

# User Manual

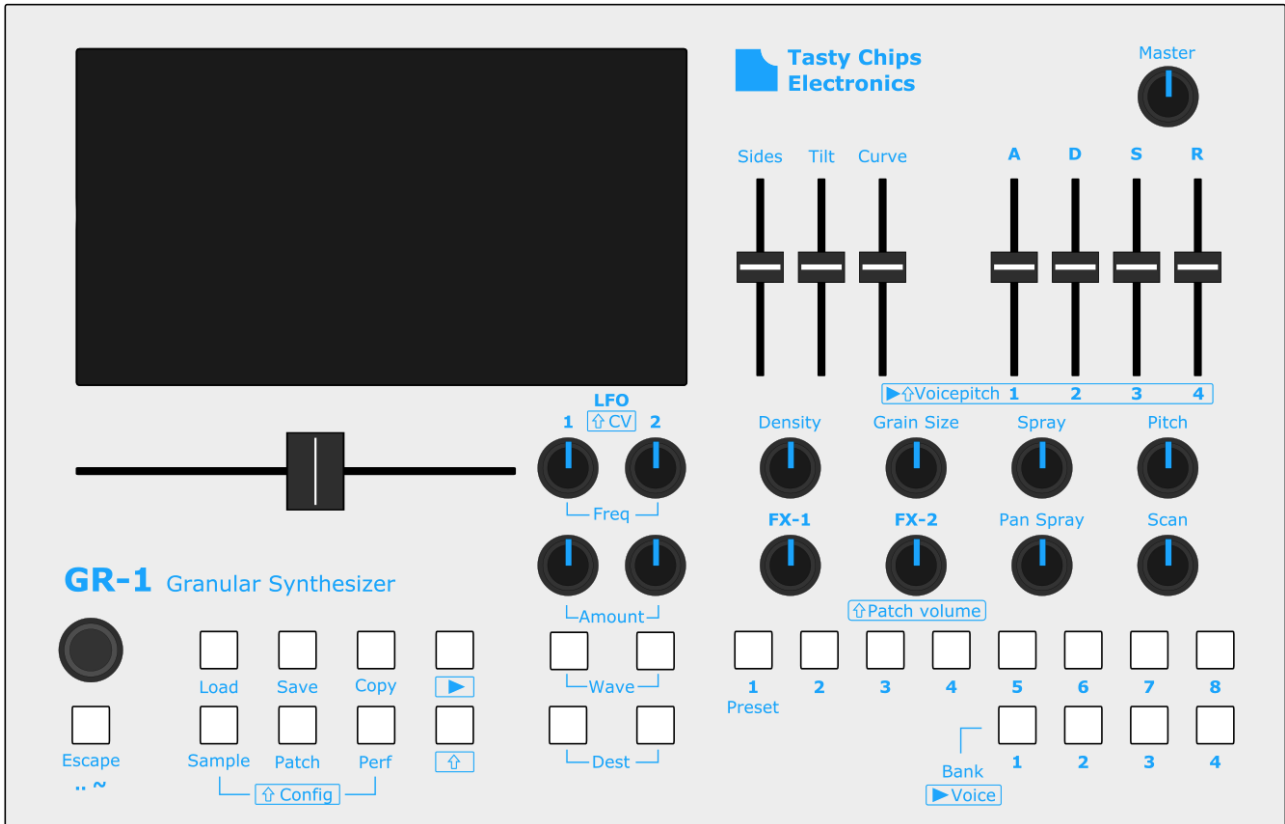

# GR-1 Granular Synthesizer

**This manual is written by:**

Pieter van der Meer

Koen Pepping

-Tasty Chips Electronics (2017-2021)

**Illustrated by:**

Luc Derks

# The history of the GR-1

The idea of the GR-1 came up 4 years ago, when our friend Erwin Tuijl, from the band “Pocket Knife Army”, brought up the idea of a hardware granular synthesizer.

Pieter van der Meer, Koen Pepping and Jasper Andrea representing the Tasty Chips Team (2017), took on the idea and turned it into reality.

After a lot of brainstorm sessions, Hardware revisions, test sessions, hard work and dedication by our team, the GR-1 Granular Synthesizer was born.

We love this thing and we invested a lot into building it. We hope you will enjoy and love the GR-1 as much as we do!

In 2018 through 2021 many new features like live sampling, different play modes, and multi-timbrality were added. As we write this, the GR-1 is still being improved.

Thank you for buying the GR-1 Granular Synthesizer!

-Tasty Chips Electronics (2017-2021)



## Table of Contents

The history of the GR-1.....	3	Basic Tutorials.....	30
Version naming.....	6	Modifying and saving.....	30
Contents of the box.....	7	From sample to patch.....	31
Warranty.....	8	A clean slate.....	32
Important notice!.....	9	MIDI.....	33
GR-1 Specifications.....	11	MIDI in.....	33
Quick start guide.....	12	MIDI thru.....	34
Global Overview.....	13	USB MIDI.....	34
Position slider.....	14	MIDI OUT (USB only).....	34
Display.....	14	Set MIDI channel.....	35
Grain window.....	15	MIDI program changes and banks.....	35
Voice Envelope section.....	15	List Of Tested (USB)MIDI controllers and	
Knob Section.....	16	keyboards.....	36
LFO section.....	16	Audio Input.....	37
Presets.....	17	Configuration.....	37
Menus, and disk access.....	17	Looping rec.....	37
Select knob & Escape button.....	18	Record start mode.....	37
Global Overview (Back Panel).....	19	Rec level.....	37
On/off switch & DC adapter.....	19	Sample size.....	38
MIDI in & thru.....	19	Clear sample.....	38
USB connection.....	19	Recording samples.....	38
CV & Gates.....	19	Supported USB sound cards.....	39
Audio output.....	19	Importing Samples from external drives.....	41
Headphone connection.....	19	Sample Formats.....	41
Granular Controls.....	20	Loading samples.....	41
Density.....	20	Copy samples.....	42
Grain Size.....	20	Saving samples.....	42
Spray.....	21	Naming.....	42
Pan Spray.....	21	Sample Tuning.....	43
Panning.....	22	Patch Load & Save.....	44
Scan.....	22	Saving a patch.....	44
Direction.....	23	Naming.....	44
Tape Mode Controls.....	24	Incremental patch saves.....	45
Loop Start & End.....	24	Loading a patch.....	45
Low Frequency Oscillators (LFO).....	25	Copy a patch.....	46
Rate.....	25	Kill a preset.....	46
Waveforms.....	25	Patch volume.....	46
Aux LFO waveform.....	26	Patch Configuration Menu.....	47
Modulation matrix.....	27	Patch configuration.....	47
MIDI clock synchronization.....	27	Patch Global Settings.....	47
Control Voltage (CV).....	28	Name.....	47
CV inputs:.....	28	Sample mode.....	47
CV Amount & Destination.....	28	Spawn mode.....	47
Gate output:.....	29	Grain stealing threshold.....	48
Example patch:.....	29	Keyboard tuning.....	48

ADSR Pile-up.....	48	Load sample: convert to 44.1.....	56
Grain Key Sync.....	48	MIDI CC updates visuals.....	56
Grain Clock Sync.....	48	Patch switch -> stop grains.....	56
Sample loop confinement.....	48	Pitchbend range.....	56
Resample anti-aliasing.....	48	DSP Metering.....	56
Granular glide.....	49	MPE.....	56
Patch Scan Settings.....	49	File selector: Sound previews.....	56
Scan Key Sync.....	49	Send precision CC.....	57
Scan loop confinement.....	49	Check Firmware Upgrade.....	57
Scan mode.....	49	On board chord toggle mode.....	57
Scan clock sync.....	49	Saving a Performance.....	57
Patch Play Mode Settings.....	50	Performance quick save.....	58
Responds to play.....	50	Loading a performance.....	58
Slider base note.....	50	Initializing a performance.....	59
Free scale.....	50	Copy preset to “all” .....	59
Play scale.....	50	Timbrality.....	60
Patch FX settings.....	51	Entering multitimbral mode.....	60
FX type.....	51	Polyphony.....	61
FX mapping.....	51	Forms of polyphony.....	61
Filter mode.....	51	Voice timbre.....	61
Sub-oscillator.....	51	Note hold.....	61
Sub-osc balance.....	51	Voice stealing.....	61
Patch Modulation Settings.....	52	Grain stealing.....	61
LFO2->Delay sync.....	52	Audio, and avoiding drop-outs.....	62
Cubic LFO amount curve.....	52	Master volume and patch volume.....	62
LFO 1 or 2 Sync.....	52	Grain window modification.....	62
LFO 1 or 2 Key Sync.....	52	Temperature and the internal fan.....	63
LFO 1 or 2 max freq.....	52	Menu screens.....	63
Mod Wheel -> LFO 1 or 2.....	52	MIDI Control Change (CC) table.....	67
LFO1->2 Cross Modulation.....	52	Firmware updates.....	73
LFO 1 or 2 Quantization.....	52	Frequently Asked Questions (FAQ).....	75
Modulation Matrix.....	53	Troubleshooting.....	77
MPE Position clipping.....	53	File systems (USB disk/stick format).....	77
Patch Keyboard.....	54	Multiple USB sticks or USB drives.....	77
Keyboard split 1,2.....	54	Firmware upgrades.....	77
Area 0..2 – Pos offset.....	54	Crashes.....	78
Area 0..2 – Keyboard -> Pos.....	54	Lightning bolts.....	78
Area 0..1 – Pitch.....	54	Slow USB drive or stick.....	78
Performances & Performance Configuration...55		Reflashing the internal storage.....	79
Configuration.....	55	Credits.....	81
Midi Channels.....	55	Tasty Chips Team.....	81
LED Brightness.....	55	Hired.....	81
Potentiometer Setpoints.....	55	Hardware Granular Idea.....	81
Direct shift.....	55	Special thanks to.....	81
ADSR Slider mode.....	55	Contact.....	82
Velocity Curve.....	55		

# Version naming

## Version naming convention

This document's version is written as v<major>.<minor>.<patch level>

The major and minor versions follow the GR-1 firmware versions. The patch level is separate from the firmware version's patch level. Major version updates involve a complete redesign of the user interface and possible feature additions. Minor version updates involve feature additions.

Firmware patch level updates purely involve bug fixes. Document patch level updates involve additions to documentation: yet undocumented features, and errata.

## Document version

2.5.1

## Applicable firmware version

2.5.x

# Contents of the box

Firstly, congratulations! You are now the proud owner of the Tasty Chips Electronics GR-1 granular synthesizer.

The contents:

- The box with schematic drawing of the GR-1 on its top side. NOTE: this box features a sticker with serial number GR-XXXX!
- External region-independent AC/DC power supply, boxed. NOTE: AC cord not included.
- Quick start guide (single A4 sheet).
- The GR-1 unit. Later units include a sticker with serial number (GR-XXXX) on the bottom plate. The display has a protective sticker on it, which may be peeled off if you prefer.

# Warranty

The GR-1 comes with a **2 (two) year** warranty on factory defects. Warranty is effective from the date of shipping of the unit.

“Factory defects” covers:

- Missing parts (see previous section)
- Broken parts (for instance: cracked screen, broken buttons, knobs or sliders)
- Non-functional unit (“dead on arrival”)
- Semi-functional unit with serious defect (for instance: inability to access any USB stick or USB hard disk, left and/or right channels permanently muted).

In case of such defects, you can reach us at [info@tastychips.nl](mailto:info@tastychips.nl), and claim your unit to be repaired. We’ll contact you with all the necessary information for return shipping and will refund all postage costs incurred. Please understand that shipping and repairs may take several weeks depending on the severity of the defect and your location in the world.

We’ll first attempt to repair your unit. If, and only if, the unit is damaged beyond repair, we’ll send a new unit.

In some trivial cases like missing power adapter, or broken SD card, we will send the replacement parts directly to you, because they may be easily replaced.



## Important notice!

### Warning!

Do not use an adapter other than the one that comes with the GR-1.

Do not connect high voltage to the input/output connectors of the GR-1.

Avoid this product from falling, spillage of fluids, dust and keep this product out of damaging environments. Keep your GR-1 out of range of children and pets.

Do not open this product. Please contact Tasty Chips Electronics when (part of) your GR-1 does not work (when you see a greyscreen), contact information can be found on the last page of this manual.

Please treat your GR-1 with love and affection <3

### Power supply and power lead

The GR-1 comes with its own external AC/DC power supply. A power lead is not supplied, however. This is because there are many types (one per world region), and most people have a couple lying around at home. For more information, look up the IEC-60230 C13/C14 cable specs [[https://en.wikipedia.org/wiki/IEC\\_60320](https://en.wikipedia.org/wiki/IEC_60320)].

If you want a spare power supply:

- Brand: **Mean Well**
- Model: **GST18A09-P1J** (or **GS18A09-P1J** on older units)

### Power specification

Please do not use an adapter other than included in the GR-1 package. Using another adapter or power source, may cause damage to your GR-1. It is protected against reverse polarity and overvoltage, but extreme voltage will still cause damage! The GR-1 accepts heavier 9-12V adapters than the supplied 20W unit, but please contact us before trying!

Using USB devices with the GR-1 will draw extra power, but most of these devices: MIDI controllers, USB sticks, sound cards and even USB drives, are ok. However, it may be that connecting too many devices will cause power issues. Beware! If you are not sure, it's best to plug in devices only when the GR-1 has fully booted.

## **Reading this manual**

The GR-1 is designed as an easy-to-use device, but we also wanted to give the user access to more complex functions. To get the GR-1 up and running in a short time, you can read the Quick start guide. This manual is intended if you want to know more, and take full advantage of everything the GR-1 has to offer.

This manual starts with the basics like a feature overview, the one page quick start guide, followed by a global overview of all the on-board controls and sockets. It then continues on to a couple of quick tutorials that move beyond twiddling and playing, and into properly using the GR-1 to build your own patches, storing them, etc. Beyond that are the chapters with detailed explanation of all the menus and connectivity options (MIDI, sound cards, USB sticks), and details of the on-board controls.

For the sake of completeness and getting the most from your GR-1, there's still more background information on the GR-1 engine, followed with tables of all on-board and MIDI controls. The manual ends with FAQ, troubleshooting and firmware upgrade chapters.

# GR-1 Specifications

- **128 grains per voice**
- **11 voice** polyphony
- **4 part** multitimbral
- **Standalone** or **MIDI** controllable, **MPE** capable
- MIDI IN & MIDI THRU connection with **DIN** and **USB MIDI**
- **Audio input** and **live recording** via **USB soundcard**
- High quality stereo audio: internally 32 bit float, DAC: 44.1KHz, 106 dB SNR
- High quality headphone amplifier with dedicated volume control
- Quad core ARM Cortex-A running optimized Neon SIMD code
- 800 x 480 pixel, **7" TFT true color display**
- **Firmware updates** via **USB**, and over **internet**
- **Sample file uploads** in multiple formats via USB
- The GR-1 can handle 32 **sample files of 10 MB** (about 2 minutes long)
- Presets and performances can be saved to **internal flash (4GB, or 20GB** in later models) or **external (USB) memory**
- **2 control voltage** assignable inputs 0-5V with voltage protection
- **1 gate** output
- 12dB/oct digital **multimode filter** with direct and MIDI controls
- 2 assignable **LFO's** with waveforms (sine, random, saw, square) and direct controls
- **LFO wave recording**
- **4 banks of 8 presets** all hands-on accessible and overwritable
- ADSR amplitude envelope and Grain window envelope with direct controls
- Rotary encoder for configuration, file/sample selection. Configuration menus provide **extended possibilities** beyond what the pots and sliders offer.
- Access to **configuration** screen providing many more options
- **31 x 21.5 x 6 cm** aluminum casing
- Full MIDI control: All on-board sliders and knobs, and internal controls are represented as **MIDI CC**. Full support for program change, pitch bend, and the entire modulation matrix. High resolution **NRPN CC's** also supported on every control.
- Ability to read and write to many USB sticks or drives: ExFat, NTFS (Windows), HFS+ (Mac, read-only), Ext4 (Linux).

# Quick start guide

To get your GR-1 Granular Synthesizer up and running (stand alone), you can simply connect your headphone and follow the next steps:

1. Connect the adapter that came with your GR-1 to the DC connector at the back of your GR-1. Use your own IEC-60230 C13/C14 power lead [[https://en.wikipedia.org/wiki/IEC\\_60320](https://en.wikipedia.org/wiki/IEC_60320)]. Turn on the power switch (see figure below). The display and buttons should now light up.

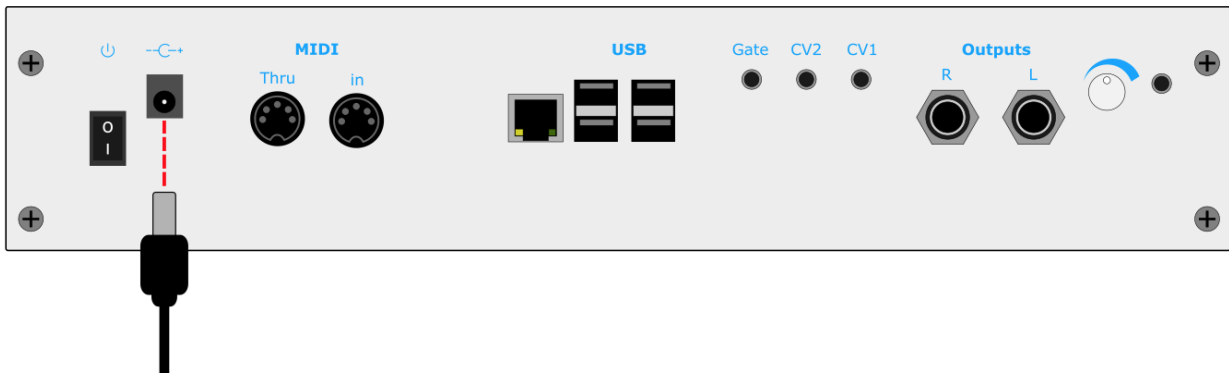

2. **1** Press the “play” button, a single voice will now play constantly and “bank” button 1 will light up, indicating voice 1 of 4 is playing.  
**2** The other 3 “bank” buttons will trigger voice 3-4 to play.  
**3** Holding down the **shift button** while “Play” is lit, the ADSR sliders will now function as pitch controls for the 4 voices, making it possible to play chords and drones. See figure below.

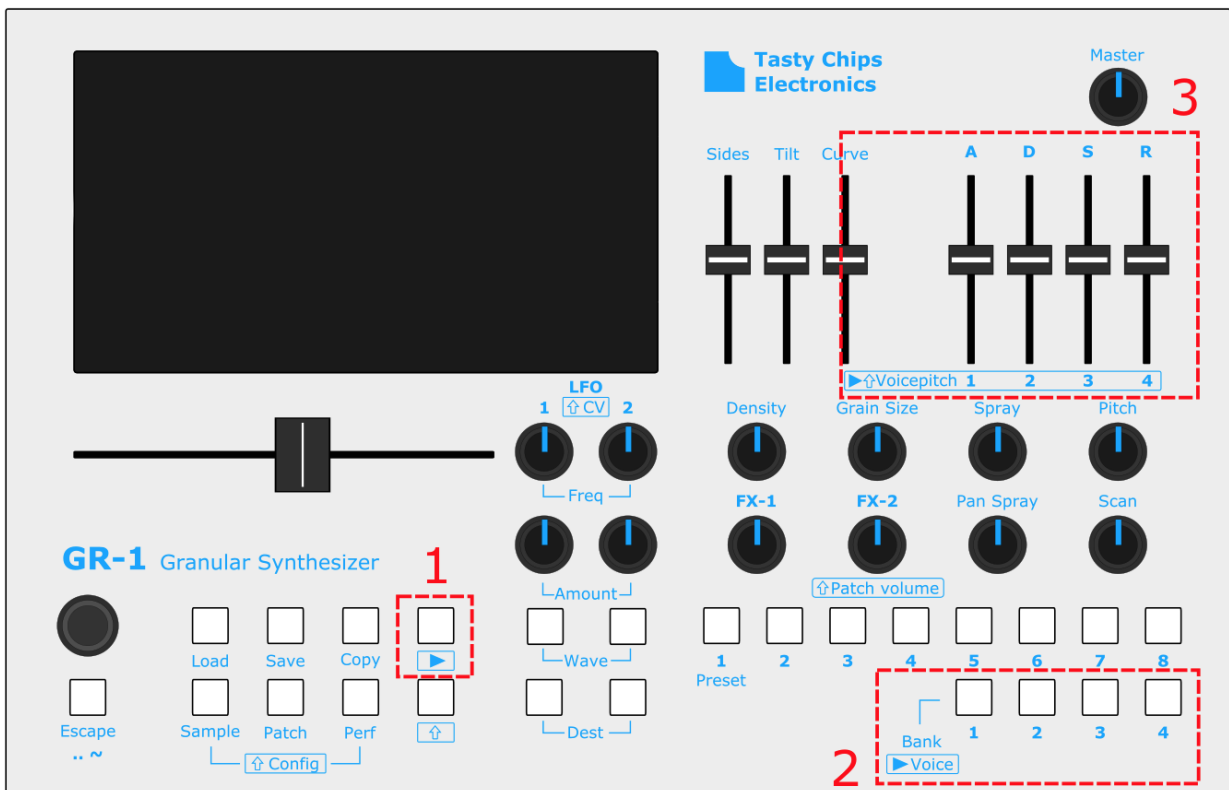

# Global Overview

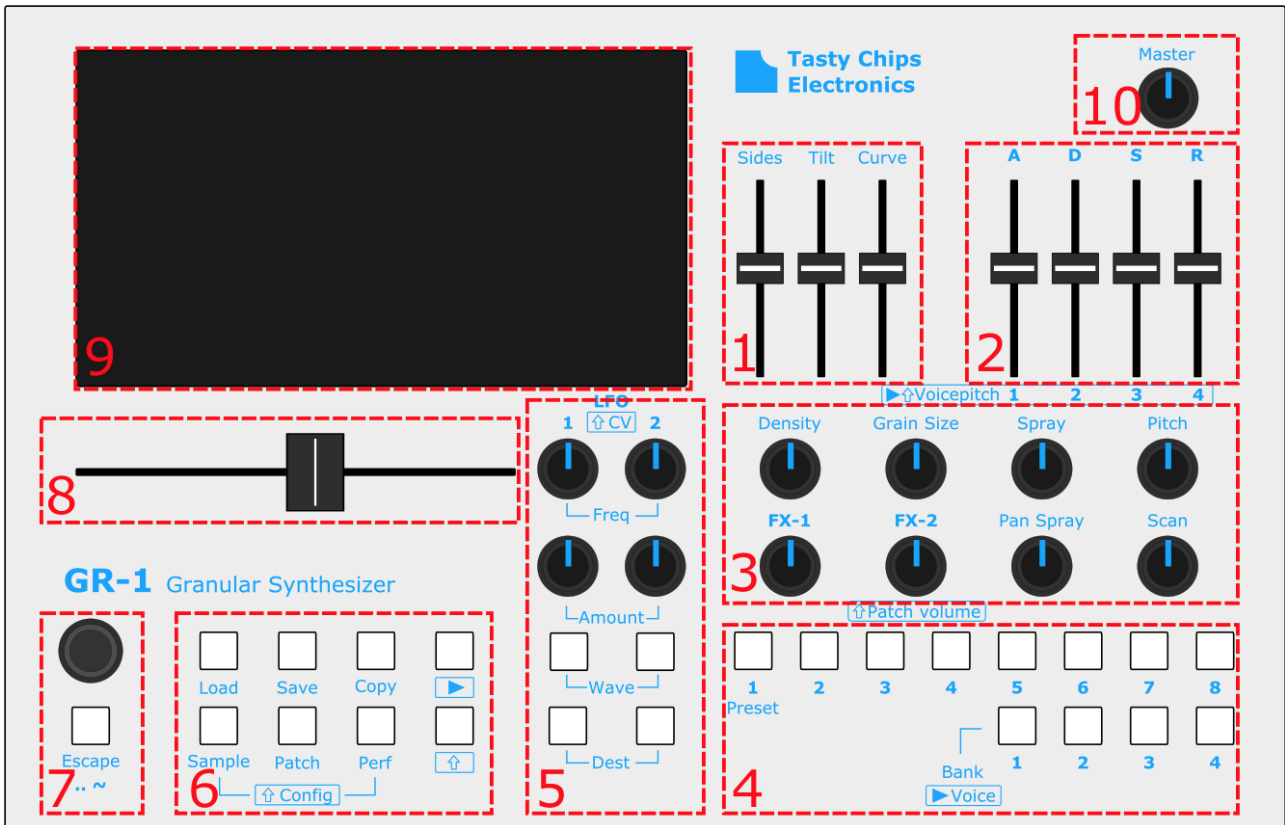

1. Grain window section (Sides, tilt, curve)
2. Envelope section (ADSR)
3. Knob section
4. Presets
5. LFO section
6. Playing, menus, copying, and disk access
7. Select knob & Escape button
8. Position slider
9. Display
10. Master Volume

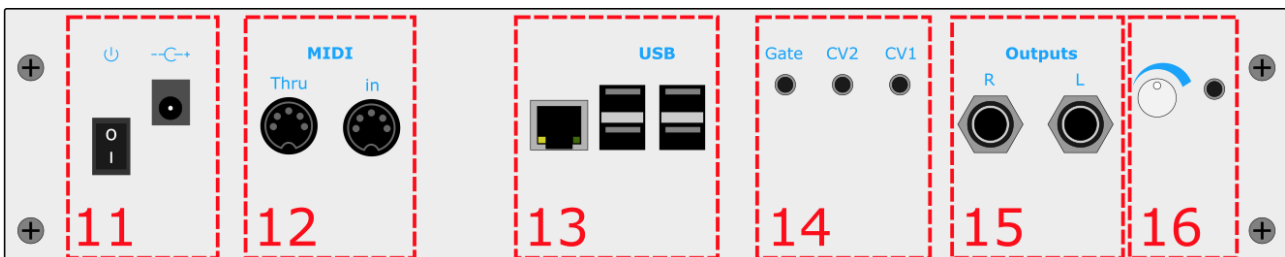

11. On/off switch & DC adapter
12. MIDI in & thru
13. USB connection
14. CV & Gates
15. Audio output
16. Headphone connection

## Position slider

The position slider is the control for the sample play position. The slider will correspond to the position of the vertical blue line in the sample display:

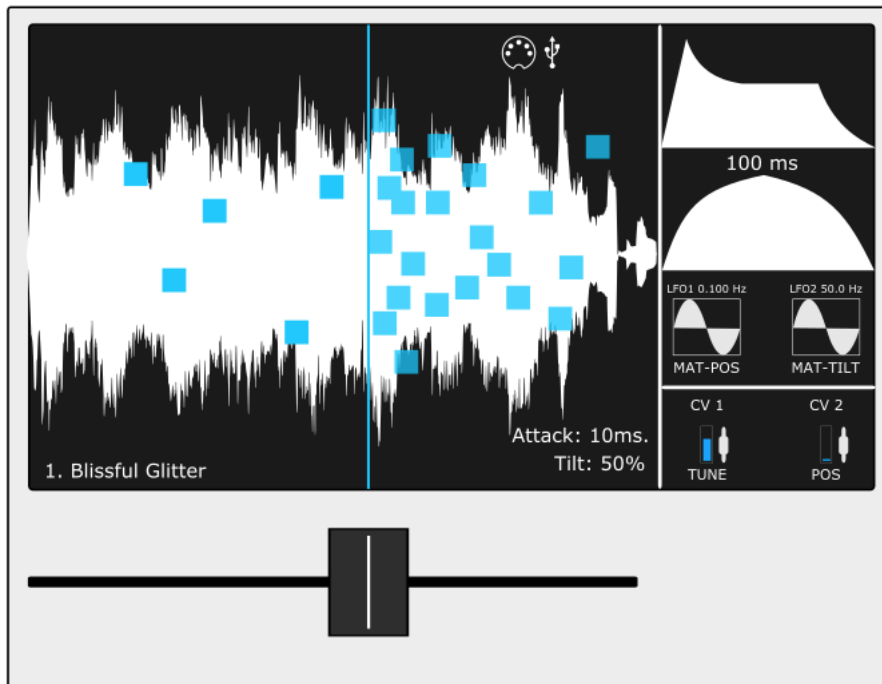

## Display

The display visualizes everything that is happening in your GR-1. Most icons and interface details are already explained in the previous paragraphs (ADSR, window, LFO waves etc.), but here are some icons that are not explained yet. The icons display (from left to right):



- MIDI events via DIN inputs
- MIDI events via USB
- Knob/slider event
- Potentiometer Setpoint locked (until value is matched by dialing to the set point).

## Grain window

The grain window is an amplitude envelope for each grain. The length of the window slopes is relative to the grain size that was set. In other words:

- **A window is always exactly as long as the grain size.**

The parameters of the grain envelope are (see the illustration below):

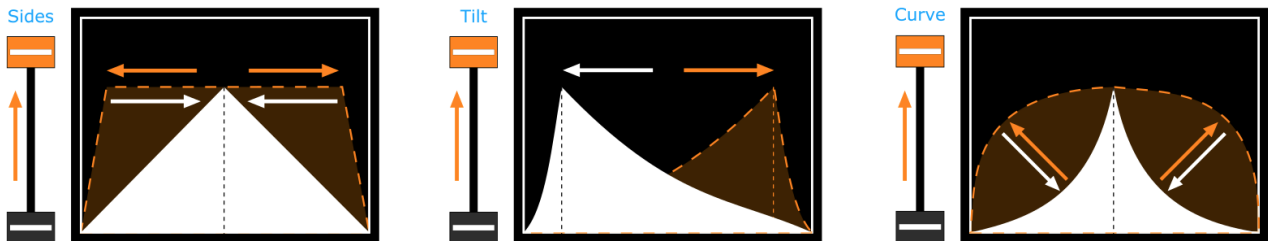

*(The grain window envelope is shown on the middle-right side of the GR-1 display column.)*

Note: Shift + Sides controls loop start and Shift + Curve controls loop end. They can be fine tuned by turning the “select” knob. The GR-1 supports down to 1 sample frame resolution on sample loops.

## Voice Envelope section

The amplitude envelope is triggered when a key/voice is active. The envelope is a standard Attack, Decay, Sustain, Release envelope. The Attack, decay and Release times can be set between 0-12 seconds. The Attack slope is linear, the Decay and Release slopes are exponential.

**A = Attack    D = Decay    S = Sustain    R = Release**

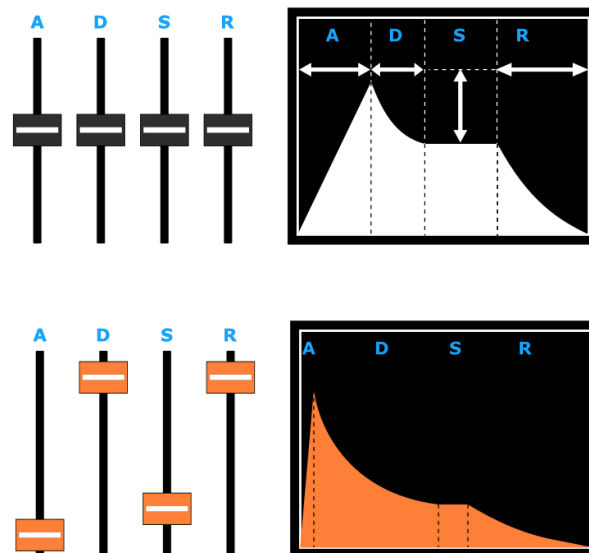

*(The voice envelope is shown on the middle-right side of the GR-1 display column.)*

## Knob Section

The knob section is a section of 8 single turn potentiometers/knobs. All knobs have their own functionality:



## LFO section

The GR-1 has 2 assignable Low Frequency Oscillators (LFO's). The LFO's can produce 2 different waveforms as modulating signal for different parameters. The controls of the LFO's from top to bottom:

- Frequency: controls the speed of the modulating signal
- Amount: controls the amount of modulation
- Wave: selects the waveform of the modulation signal
- Dest: selects the destination parameter to modulate

*(Read more about the LFO controls and options in chapter "LFO".)*

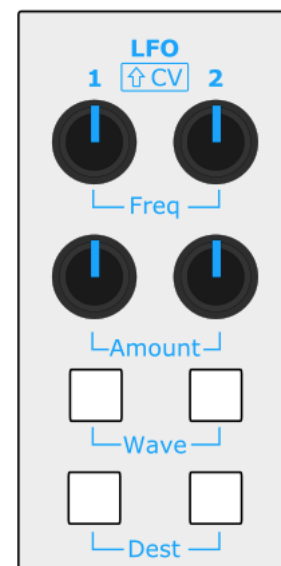



## Presets

The GR-1 is able to store 4 banks of 8 direct accessible preset patches. You can save and load these presets, and copy them.

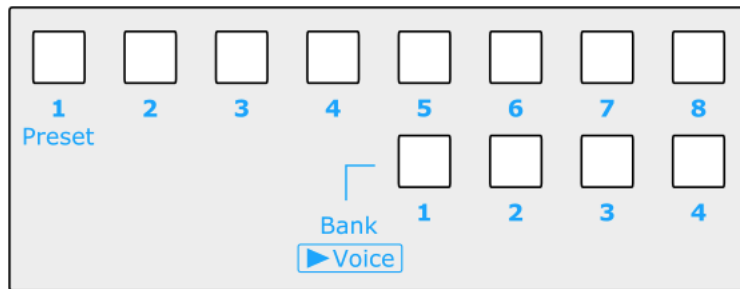

In the figure above, you see that the 8 buttons on top are the presets, the 4 buttons below are the banks. The button of the selected bank/preset will light up. Read chapter “Patches and patch configuration” to learn more about saving, loading and copying presets.

## Menus, and disk access

There are 3 menus the GR-1:

- Sample
- Patch
- Performance

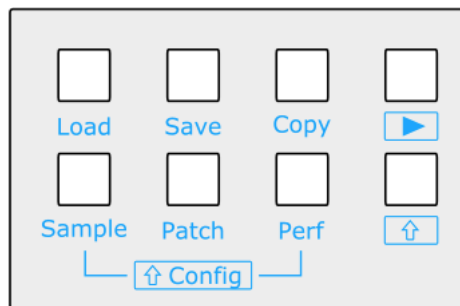

These modes can be selected with the buttons “Sample”, “Patch” and “Perf”. Each mode has its own file formats and filter for them in the load and save file selectors. For instance, you can’t see sample (WAV, AIF, etc.) files when you’re loading a patch or a performance. Each mode also influences the copy button action. You can copy and paste samples and patches, but not performances. Only one performance can be in memory at any time.

***Read more about these modes in the corresponding chapters.***

## Play

The GR-1 has a “play” button. The play button triggers voices, and makes it possible to use the GR-1 standalone. The basics of the play function are found in the Quick start chapter in this manual. Note that holding down Shift when pressing play will enter audition mode. The granular engine will be turned off, and just a single sample will play. This is mainly for previewing purposes, but can also be used for musical purposes as modulation and all position controls are also active.

### Load, Save and Copy

The GR-1 is able to load, save and copy patches and performances. The load, save and copy functions are explained in different sections of this manual. Please read this manual.

### Shift

When active, the shift button allows buttons and knobs to have different functions. The shift button gives access to parameters that don't have to be directly accessible.

### Select knob & Escape button

The "select" knob can be used to scroll through and select from menus. Scrolling is done by rotating/turning the knob. Pressing the select knob activates a menu item. To leave menus and go back to the previous step press "Escape". Holding down "Shift" while scrolling, increases the scroll speed tenfold.

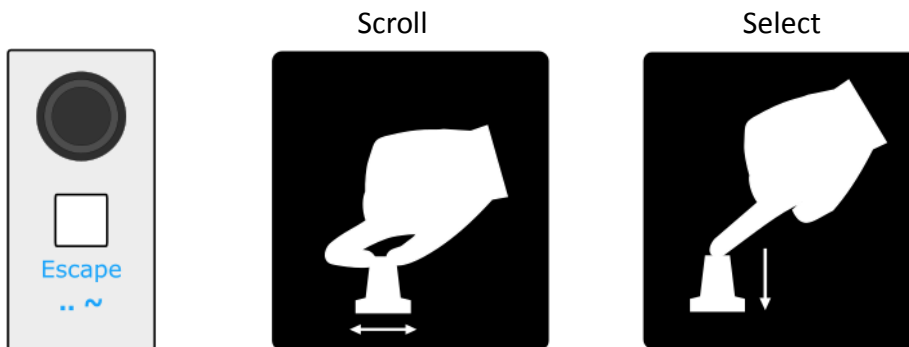

# Global Overview (Back Panel)

## On/off switch & DC adapter

The DC adapter can be connected to the DC jack input. The on/off switch turns the whole GR-1 on or off.

**WARNING: Do not use an adapter other than the one that comes with the GR-1. If you insist, please contact us first.**

## MIDI in & thru

Connect MIDI devices to these DIN connectors. See section “MIDI options” for more info about MIDI connectivity and the chapter “MIDI control table” near the end of this manual for the MIDI CC table.

## USB connection

The 4 USB ports offer various options:

- Connect the MIDI output of one or more MIDI devices to one or more of the 4 USB ports to control the GR-1 with MIDI
- Load samples from one or more USB disks/sticks
- Load (copy) and save, presets and performances on one or more USB disks
- Perform firmware updates from a USB disk
- Connect USB audio interfaces (class compliant) to record audio on the GR-1.

## CV & Gates

There are 2 CV inputs on the GR-1, which can be routed to different destinations. The gate output provides a gate signal (5V) when the GR-1 receives one or more note-on messages.

## Audio output

The GR-1 outputs high quality, low noise, stereo audio on 2 channels, left [L] and right [R].

## Headphone connection

There is a headphone amplifier on the GR-1. The knob next to the headphone controls the volume.

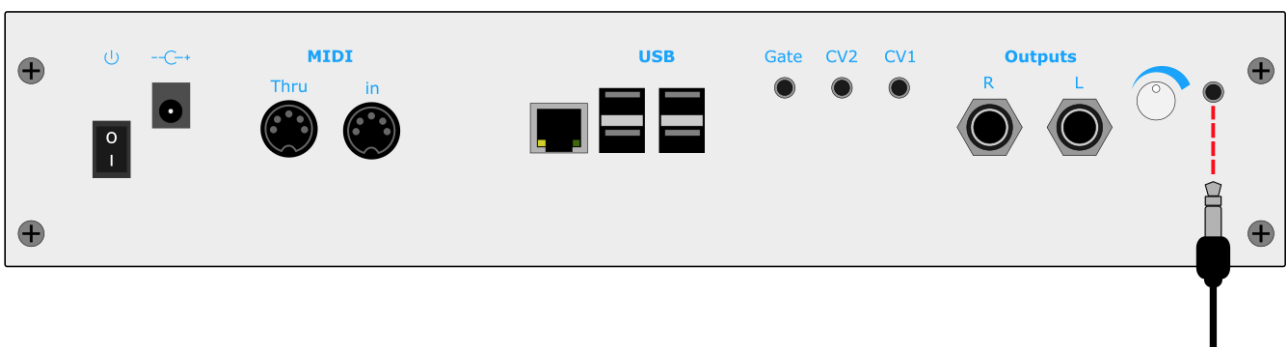

# Granular Controls

## Density

The density parameter controls the amount of grains per second (Hz). The amount can be set between 0.1-1000 grains per second, with a maximum of 128 grains playing simultaneously, per voice.

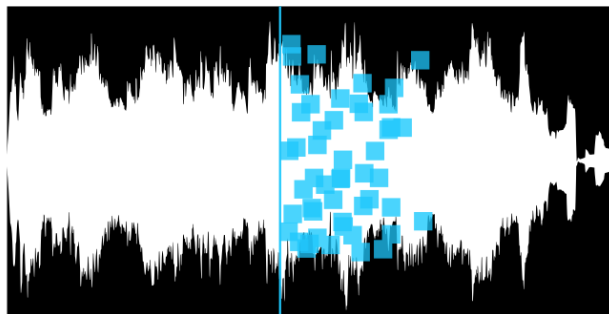
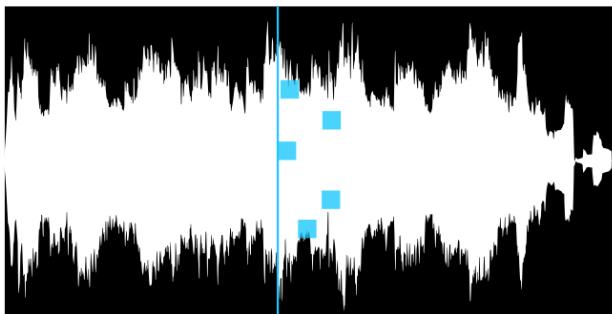

## Grain Size

The grain size parameter controls the playing length of a grain. The length can be set between 5-5000 milliseconds.

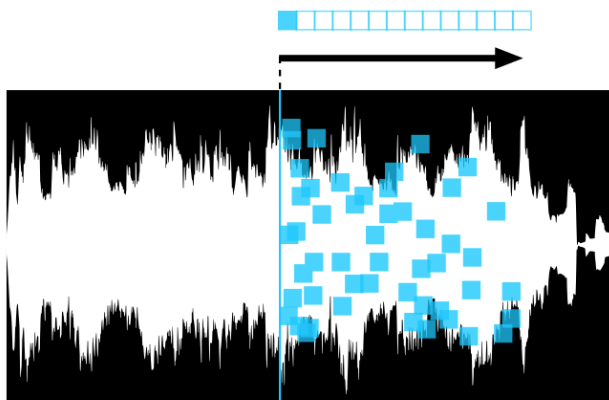
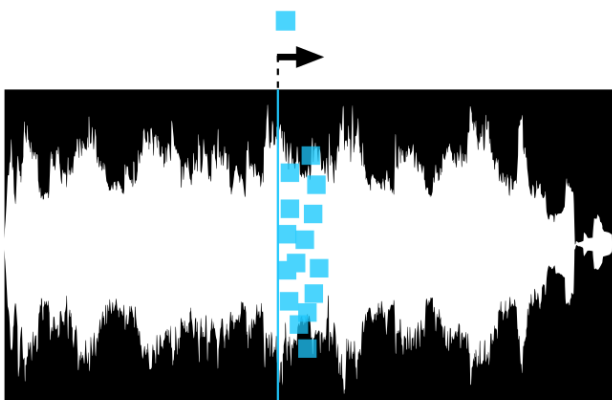

## Spray

The spray parameter controls how much a grain's start position is randomized.

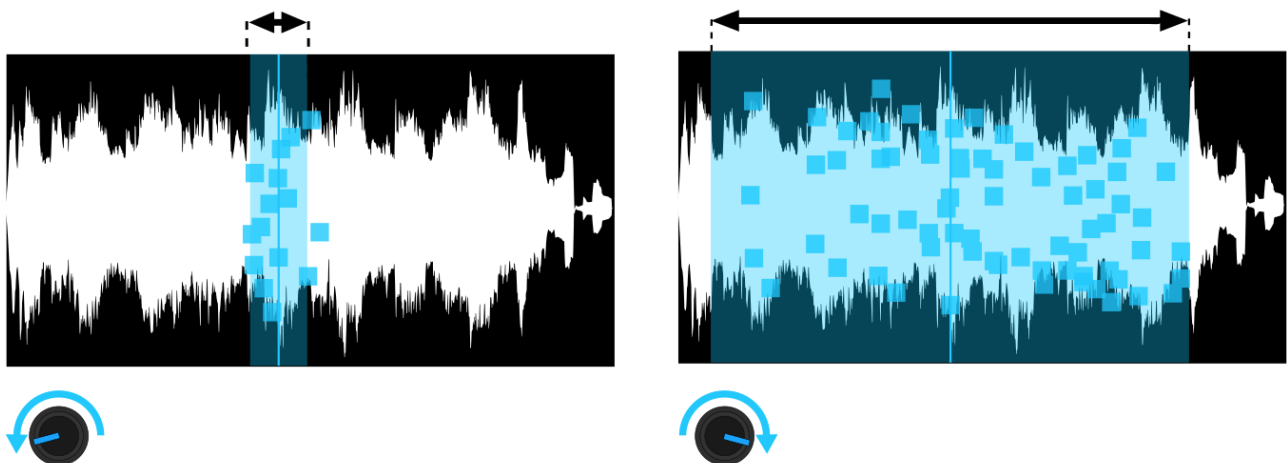

## Pan Spray

The Pan Spray parameter controls how much a grain's stereo panning is randomized. 0 means completely centered. Maximum pan spray means a grain can appear everywhere in the stereo image.

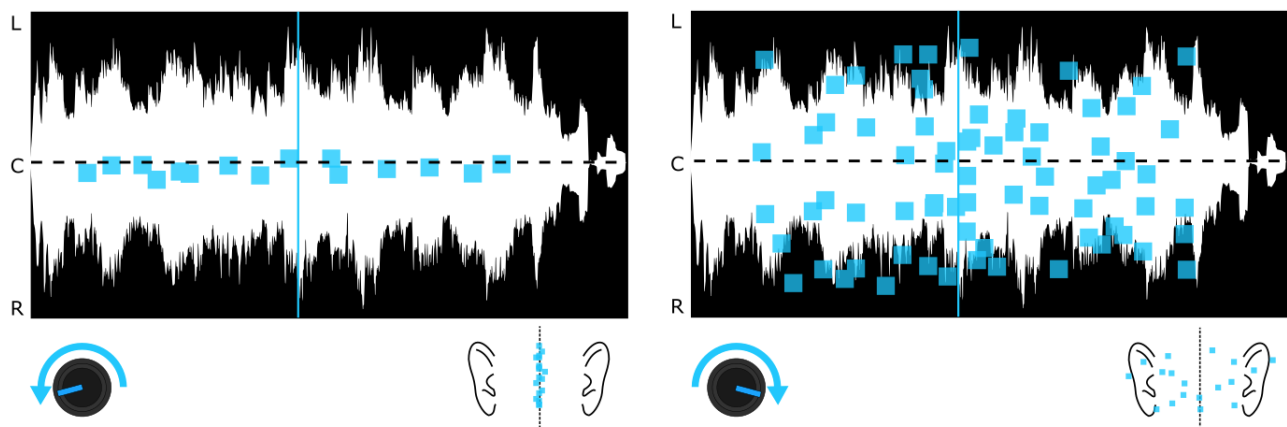

## Panning

Shift+Pan knob: The Panning parameter controls how much a grain is panned to left or right. Can be combined with pan spray.

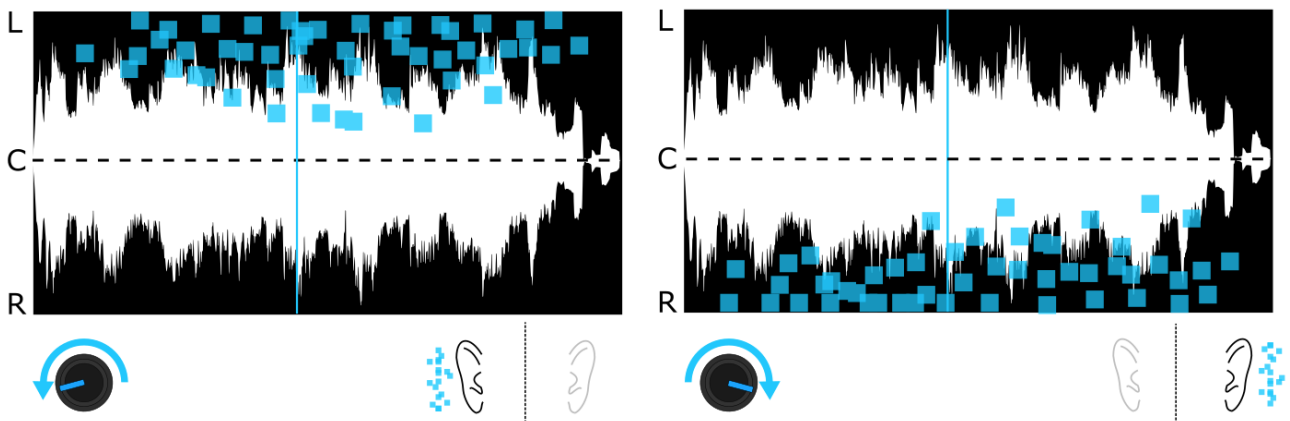

## Scan

The Scan parameter sets the movement speed of the grain start position. It can vary from -2 times (reverse motion) the sample play speed to +2 times (forward motion) the sample speed.

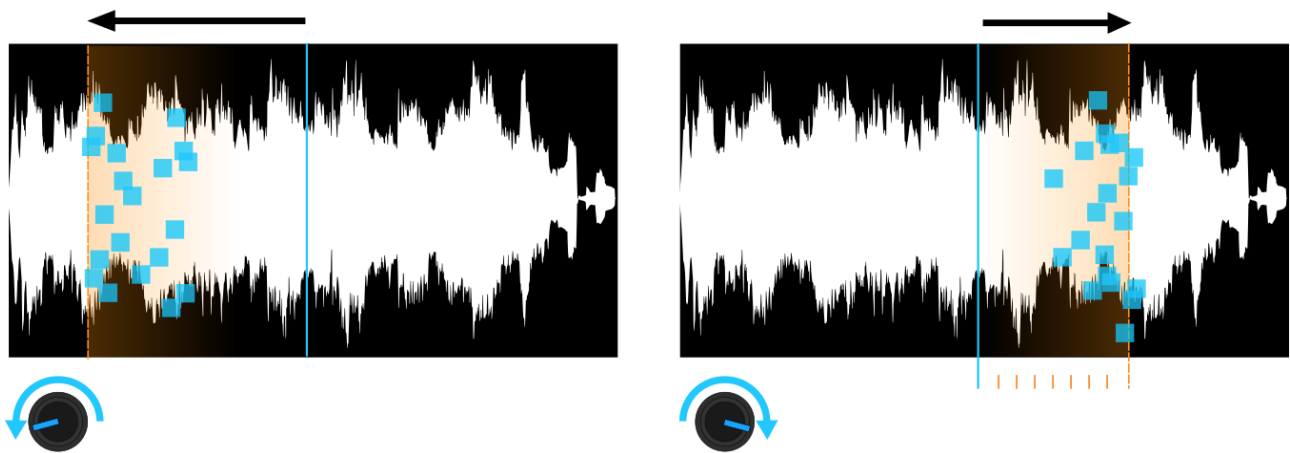

## Direction

Shift+Scan knob: Grains can run in both forward- and reverse directions. Reverse direction can be used for special effect. Combining both can be used to make the sound more lush. Setting the bias completely left plays all grains in reversed direction. Setting the bias completely right plays all grains in forward direction. The center plays in 50/50% in both

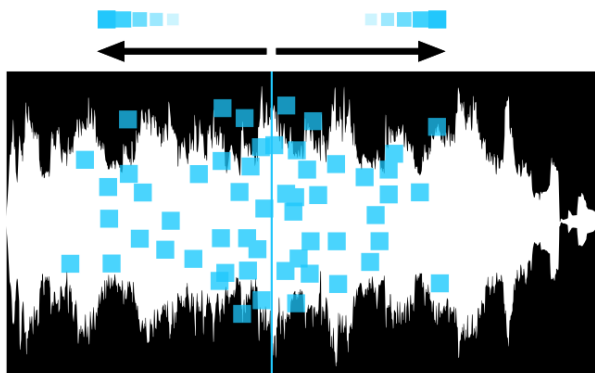
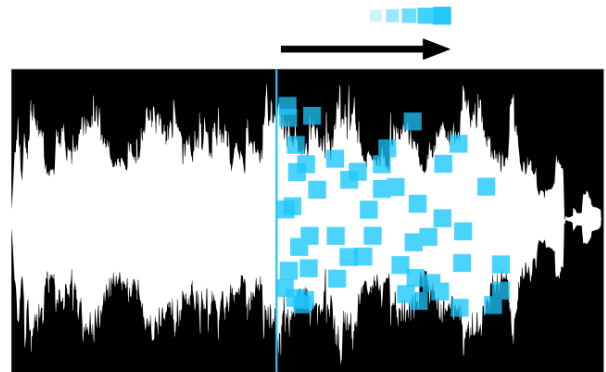
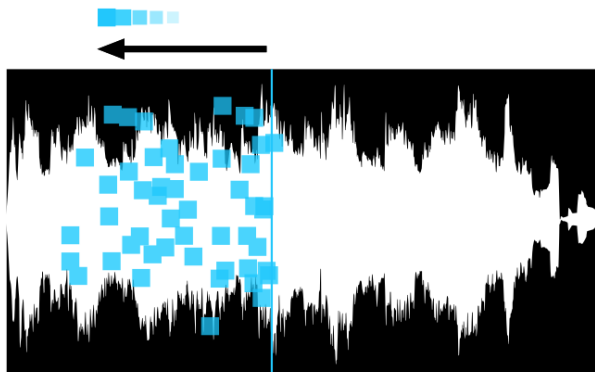

directions

## Tape Mode Controls

In 'Tape Mode' (see Patch Menu) scan and all other position controls will work like expected, but pitch controls are gone. Instead the pitch knob now controls "tape slew". This means the speed at which the tape head catches up with the scan pointer.

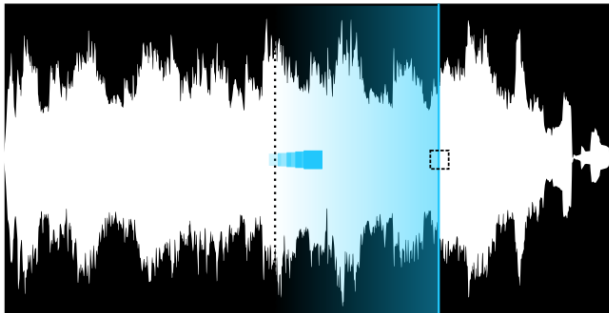
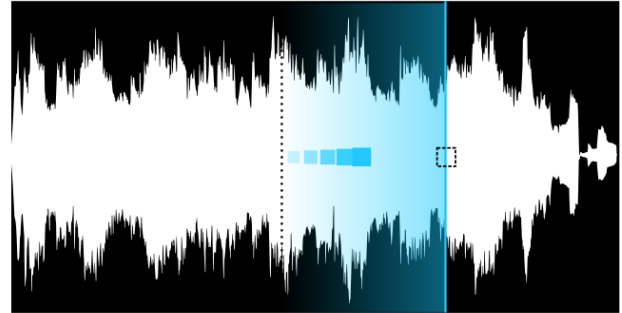
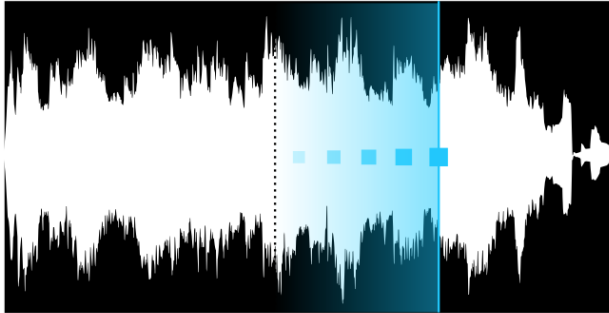

## Loop Start & End

Loop parameters set an area in which the grains wrap around. This can create tight loops which alter pitch perception.

*Set Loop Start: Shift + Sides*

*Set Loop End: Shift + Curves*

*Fine-tune Turn the Select knob directly after setting Loop Start- or Loop End.*

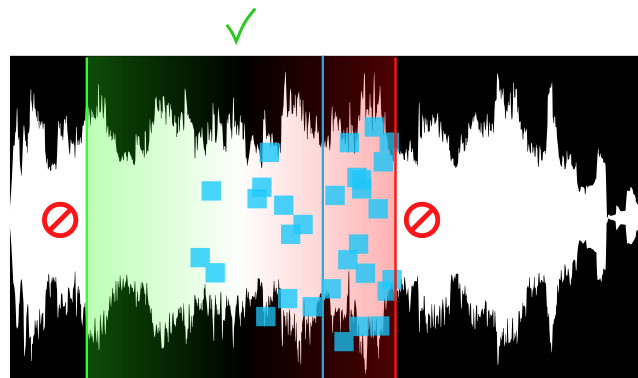



# Low Frequency Oscillators (LFO)

## Rate

LFO frequency ranges from less than 0.0001 Hz (hours!) to 50 Hz, and can be set in 1024 steps using the potentiometers using a cubic curve. The LFO frequency range can be set in the Patch menu under “LFO 1 / 2 max frequency”.

It’s also possible to fine tune LFO frequency by turning Select after you’ve touched the LFO speed knobs.

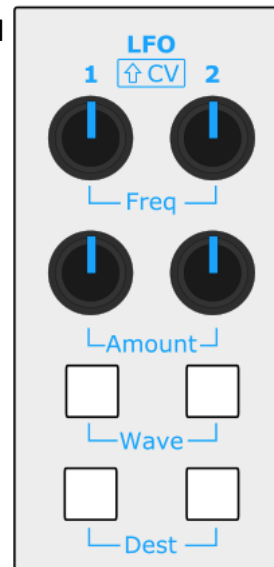

## Waveforms

The GR-1 has 2 assignable Low Frequency Oscillators (LFO’s).

The LFO’s can produce 5 different waveforms:



*(waveforms from Left to Right)*

- Sine waveform
- Square waveform
- Saw waveform
- Sample & Hold waveform
- AUX waveform

The waveforms can be selected with the “Wave” button. The frequency can be controlled with the “Freq” knob and the amount of modulation can be controlled with the “Amount” knob. The destination to be modulated can be selected with the “Dest” button. Both LFO’s are identical.

## Aux LFO waveform

The fifth LFO waveform is called “AUX” or auxiliary. It is a user-defined waveform that can be recorded by using the position slider. By default the AUX waveform is empty. To record it:

1. Press Shift + Wave (1 or 2). The display will indicate that recording is ON.
2. Move the position slider in the movement you want.
3. Press Shift + Wave (1 or 2) again. The display will indicate that recording is OFF.

Recording is done at about 60 Hz. The buffer size is 1024 points. That means you can record about 70 seconds of movement.

Replaying the AUX waveform using the LFO's means you can stretch it out to an hour or compress it to 20 milliseconds. The AUX waveform is interpolated for smooth movement.

A recorded AUX waveform will be stored inside the patch data, **if the patch is saved.**

## Destinations

At the time of writing (firmware 2.1 onwards) there are 11 MOD destinations:

- TUNE (Pitch)
- POS (Sample position)
- SPRAY
- SIZE
- DENS (Density)
- AMP (Amplitude)
- PSPR (Pan spray)
- CUTOFF
- SIDES (Grain window)
- TILT (Grain window)
- CURVE (Grain window)

By default the GR-1 operates the LFO's and CV's in one-to-one mode: only one MOD destination per LFO or CV. More advanced users probably want to turn this off. Do this by holding down one of the Dest buttons for a while. They'll now be lit signaling that free matrix mode is enabled.

Normal MOD destinations are updated at 200 Hz. The grain window destinations: sides, tilt, are updated at just 4 Hz, and the window is linearly interpolated between 4 Hz steps at 200 Hz. The GR-1 is massively polyphonic. To enable this, a single shared window that's directly used by all playing grains was required.

See the “patch modulation settings” chapter for extended LFO options.

## Modulation matrix

Next to the direct “Dest” button control, there’s also a complete modulation matrix in the GR-1’s engine. This can be controlled by MIDI CC or via the patch menu. MPE MIDI can also be used for LFO modulation. Using the matrix it’s possible to send all modulation sources to all modulation destinations, with flexible modulation depth. But also it’s possible to have negative modulation, to invert the LFO waveforms. Only pitch and cutoff are not modulated by MPE. This is because pitch is normally modulated by MIDI’s pitch bend, and there’s only a single stereo filter at the end of the signal path.

Also see the matrix section in the “Patch Modulation Settings” chapter for more information.

## MIDI clock synchronization

This allows the LFO frequency to be synchronized to the MIDI beat clock. Multiplication and division of this clock is also possible. Use the patch menu and enable “LFO1 sync” or “LFO2 sync”. In this mode the multiplier and divider setting may be accessed with the Freq knobs

Knob controls:

Freq 1:	LFO1 clock multiplier
Shift + Freq 1:	LFO1 clock divider
Freq 2:	LFO2 clock multiplier
Shift + Freq 2:	LFO2 clock divider

# Control Voltage (CV)

The CV section makes it possible to combine the GR-1 with a modular system (Eurorack for example). The CV section contains 2 control voltage inputs and 1 gate output.

## CV inputs:

CV1 and CV2 accept voltages within the range of 0-5V. The CV inputs are protected for voltages outside of the 0-5V range, but we would still recommend to use them with care. The CV inputs are assignable to different parameters.

The CV is displayed with a mini jack cable icon. On top the CV number is displayed and below the mini jack icon the destination is displayed.

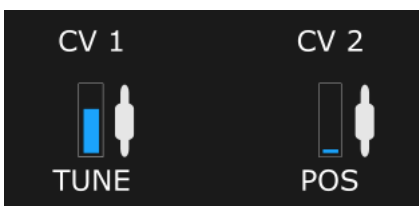
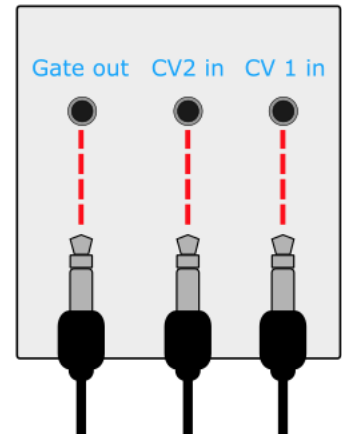

## CV Amount & Destination

To control the CV options, Press the “shift” button, to change the LFO controls to CV controls:

1. LFO amount will now function as CV amount
2. LFO destination will now function as CV destination

Note that the CV inputs are left *floating* when they're unconnected. This means that by default the amount should be turned down to zero, otherwise random modulations may result (!).

(See figure right)

LFO 1 corresponds to CV 1 and LFO 2 to CV 2.

Note: CV inputs have a 0-5V range. Voltages outside of that range will be clipped.

## Gate output:

**Warning: Do not use the gate output as an input!**

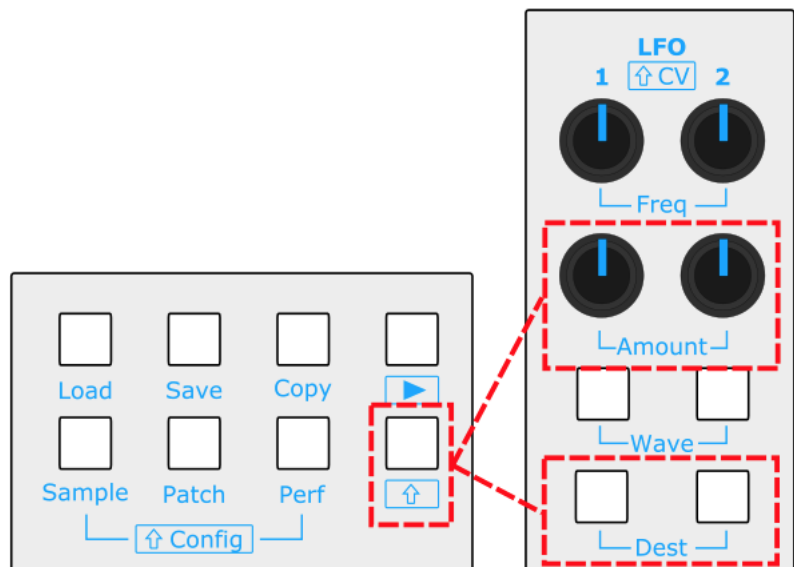

The gate output responds to incoming MIDI notes. When one or more notes are played the gate output signal will be “High”, 5V, and when notes are released/off the gate output signal will be “Low”, 0V.

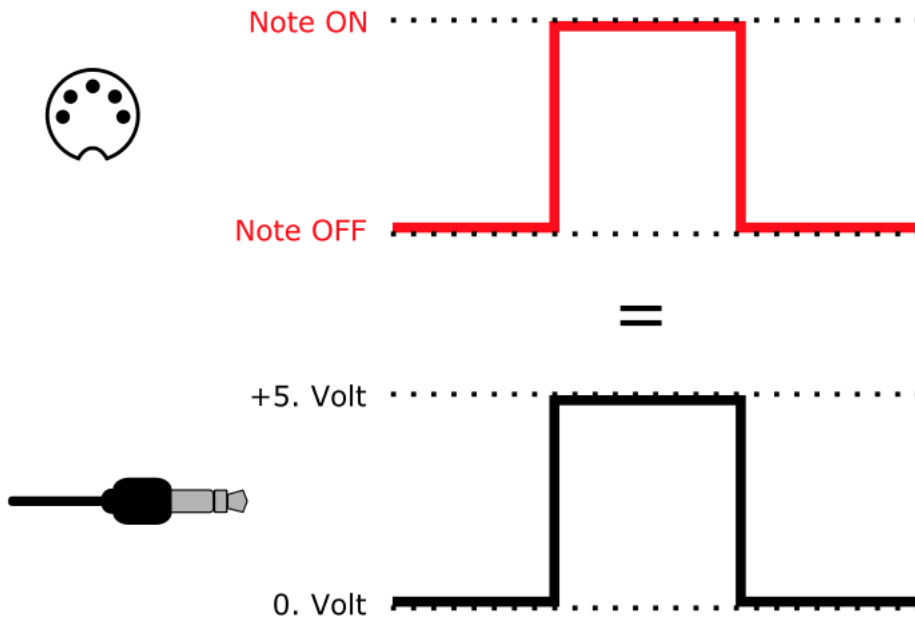

Example patch:

You can run the GR-1 audio through an external (analog) VCF.

Then control the cutoff with an external ADSR, triggered by the gate out of the GR-1.

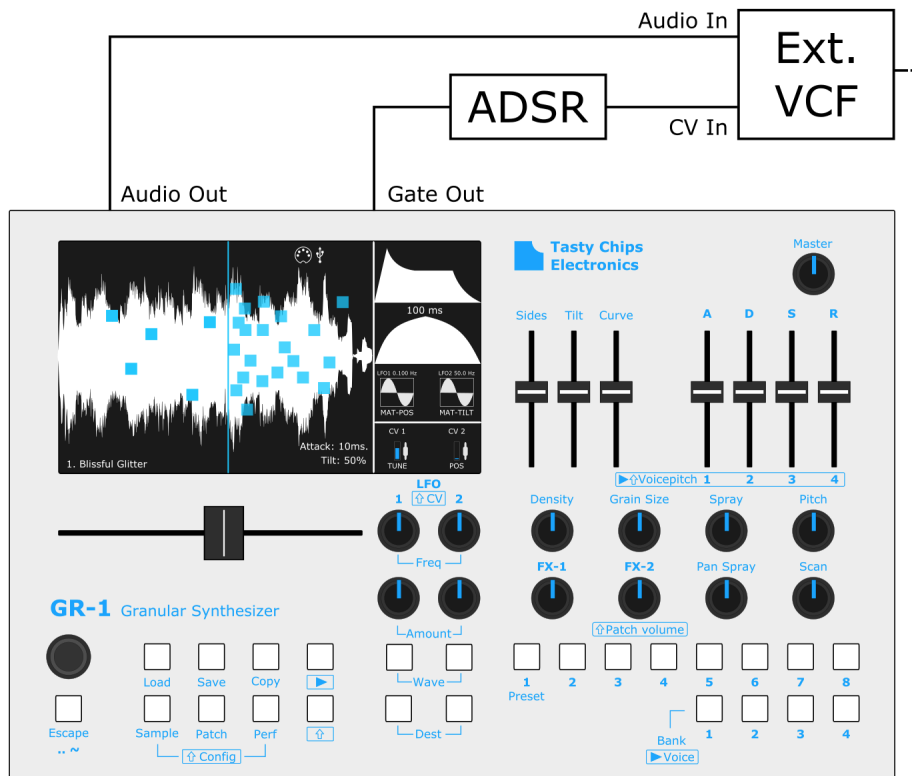

# Basic Tutorials

## Modifying and saving

The previous chapter has given you the basics of the GR-1's physical controls. This means that you can already have a taster of all the presets, and that you are able to tweak them to your liking. Since making your own patches is the first step to getting more out of your synthesizer, this chapter will explain you how to do so.

You may have noticed that tweaks will be gone after switching presets. This is because the GR-1 is designed to not to save *anything* unless you explicitly tell it to do so. A preset is a preset so to say. Even if you can overwrite it, you'll need to tell it to do so. This is a design choice to make the GR-1 suitable for live use: Presets can quickly be restored without having to go into menus to recall them, never actually interrupting the sound.

Let's make a new preset: a modified version of an existing patch. This is also the simplest way to create a new one. We'll copy the existing preset (patch) to a new preset. We'll then tweak it and make it permanent. For this we reserved a bunch of empty presets. Using the bank and preset buttons you can see that banks 3 and 4 are left completely empty, while banks 1 and 2 contain all the presets.

1. Select a preset you want to modify using the preset and bank buttons.
2. Press "Patch".
3. Press "Copy ". This button will now slowly blink indicating it's ready to paste to another preset.
4. Select an empty preset using the bank and preset buttons. For instance bank 3, preset 1. This preset is number 17 in the GR-1's memory. It will show this on the bottom of the display.
5. Press "Copy" again. The blinking will stop and the original patch will be copied into the new preset.
6. Modify some parameters like Density, sample position (using the big horizontal slider), Scan, and others. Use the Play button to hear your tweaks.
7. Press "Perf".
8. Hold down "Shift" and press "Save" at the same time. This should save your new tweaks to your new preset. This last action (steps 7 and 8 combined) is called a "Performance quick save". It's described in detail further on in this manual.

**CAUTION:** NEVER power down your GR-1 while saving. Data corruption may occur! Wait until the display responds to input again before attempting to power off.

Note that, if you didn't load another performance before you did the above steps, your newly created preset will also be present after powering down and up again. The preset is now safely stored in the default performance, located in the file chooser at:

```
/media/internal/performance1.
```

## From sample to patch

Granular synthesis depends a great deal on the input material. The logical next step is to load your own samples. The previous chapter instructed you how to modify and save presets. We're now going to load a sample from your USB drive to make a new one, with minimal effort. You'll combine the granular parameters from an existing preset with your own sample.

1. Using the preset and bank buttons, find a preset patch you like.
2. Press "Patch".
3. Press "Copy ". This button will now slowly blink indicating it's ready to paste to another preset.
4. Select an empty preset using the bank and preset buttons. For instance bank 3, preset 1. This preset is number 17 in the GR-1's memory. It will show this on the bottom of the display.
5. Press "Copy" again. The blinking will stop and the original patch will be copied into the new preset.
6. Insert your USB stick with samples. The "Load" button will start blinking, indicating mounting is in progress.
7. Press "Sample", followed by "Load". You will now enter the file chooser screen to pick a sample.
8. Select a sample by navigating with the Select knob. Turn it to scroll through files. Push it to enter a folder, or to eventually select the sample of your choosing. (If you want to quickly preview the samples see "sound previews" further on.)
9. The GR-1 will return to the main screen and display the waveform of the sample you selected.
10. Use play and the horizontal slider to find sweet spots in the sample, and adjust the granular parameters to your liking.
11. Quick save the performance just like in the previous tutorial. First press "Perf", then hold down "Shift" and press "Save" at the same time.

**CAUTION:** NEVER power down your GR-1 while saving. Data corruption may occur! Wait until the display responds to input again before attempting to power off.

Congratulations! You just created your very own patch on the GR-1. May it be the first of many. You can also use a USB sound card with your GR-1 to record your own samples and save them to presets in a similar way. Please see the "Samples and audio input" chapter on how to realize this.

You can repeat this process, and make multiple tweaked versions of your own patches until banks 3 and 4 have filled up. After this you may be interested to know that you can also load and save entire performances (32 presets + global settings). Please see sections "Loading a performance" and "Saving a performance" to find out more.

## A clean slate

If you want to start from scratch and make your own performance completely, just use one of the following:

1. “Kill” performance. This really clears everything, even the performance menu settings.
  1. Press the Perf button.
  2. Hold down Shift.
  3. Press Load.
  4. A popup will now show to ask if you want to kill the entire performance.
  5. Press Escape to cancel or press Select to kill it.
  6. You’ve now got 32 empty presets. Default patch parameters and short empty samples.
  
2. Copy a single preset to the rest of performance.
  1. Press the Perf button.
  2. Select the preset you want copied.
  3. Press Copy.
  4. A popup will now ask if you want to proceed.
  5. Press Select to paste this preset to the rest of the performance.
  
3. Copy a “template”, that is the parameters of a single preset, to the rest of performance.
  1. Press the Perf button.
  2. Select the preset you want copied
  3. Hold down shift and press Copy.
  4. A popup will now ask if you want to proceed.
  5. You can now load samples into the presets. You’ll end up with multiple different samples with the same patch template (=patch parameters).

While A allows you to start completely from scratch, B and C allow you to start from patch. While a pun might not be everyone’s cup of tea, it does stick.

What you typically want to do after this is tweak a preset and then quick save the performance, just like described in the previous tutorials. The original performance will only be overwritten when you save. The above actions A, B, and C don’t change anything on disk by themselves.



# MIDI

The GR-1 offers many MIDI control options. For details see the MIDI control table near the end of this manual. The GR-1 supports USB MIDI and DIN MIDI connectivity. There are 2 DIN MIDI connectors on the GR-1, “MIDI in” and “MIDI thru”.

## MIDI in

To control the GR-1 with MIDI, connect the output of the MIDI device to the MIDI or USB input of the GR-1:

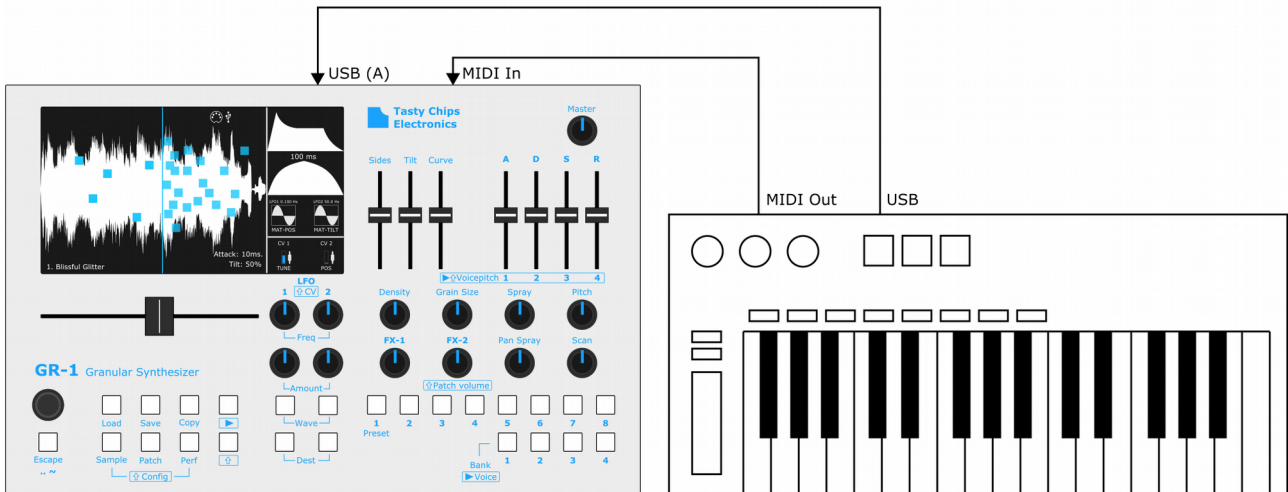

It is possible to directly hook up your DAW via the DIN MIDI IN port.

It will support all MIDI data at DIN speed (31 kbps).

MIDI IN offers support for the following MIDI commands:

- Note on/off (11 voice polyphonic, velocity sensitive)
- Pitch bend (bends all played notes in tune)
- Program changes per MIDI channel (changes the preset in each part).
- Controls (cutoff, ADSR times, LFO frequency, etc. can be controlled with MIDI controls)

See MIDI CC table at the back of this manual for the corresponding MIDI channels, CC numbers and more.

MPE MIDI controllers can be enabled in the performance menu. The GR-1 then supports pitch bend, after touch, timbre, and lift velocity, per note.

## MIDI thru

The GR-1 can be chained with other MIDI controlled devices, by simply connecting a MIDI cable from the MIDI thru connector on the GR-1 to the MIDI in of any other synthesizer:

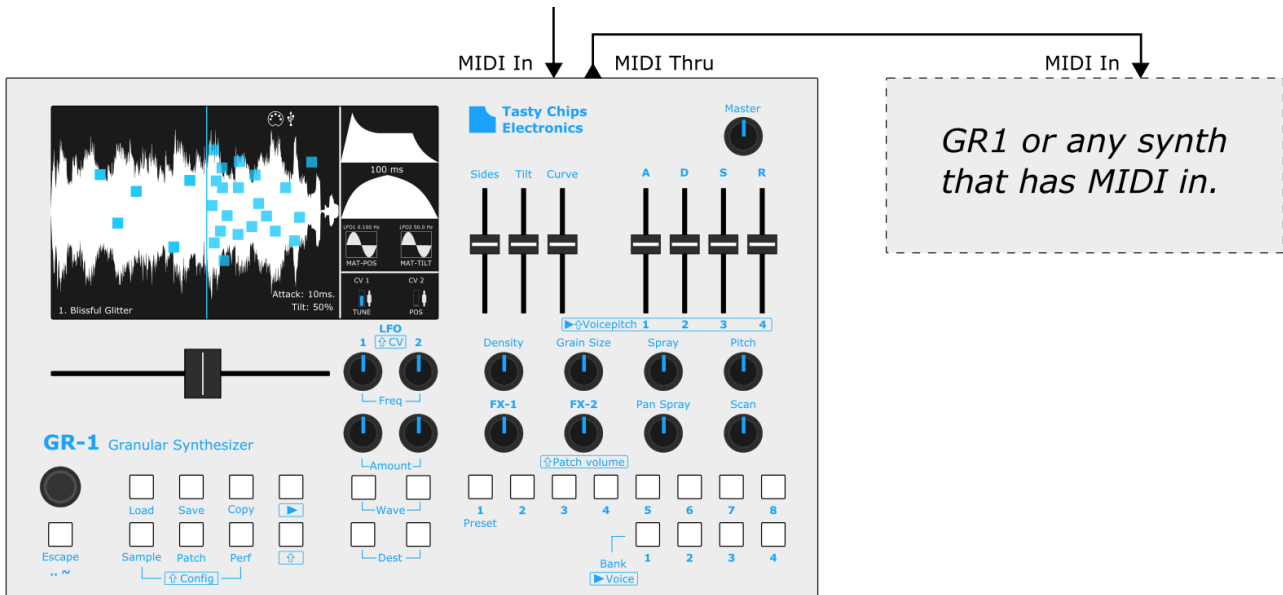

## USB MIDI

The GR-1 supports USB MIDI in host mode. That means it can directly hook up to USB MIDI controllers and keyboards via one of its 4 USB ports. At the time of writing only hooking up a single USB MIDI device is supported. It is possible to use USB MIDI and DIN MIDI at the same time, but please note that both MIDI controllers should be on different MIDI channels.

The GR-1 also supports your DAW via USB, but only via a host-to-host interface. This allows you to set up many hi-resolution automations in parallel, as USB supports a much higher data rate than DIN. Direct USB connection from host (PC/Mac) to your GR-1 is *not* possible as the GR-1 is also a USB host. Please search this manual for host-to-host interface to find out what options exist to realize this.

## MIDI OUT (USB only)

The GR-1 supports MIDI out via USB since firmware 2.4. It will generate CC's when you turn its knobs and when you move its sliders. It can also generate 14 bit precision CC's (NRPN's) if you like. This feature requires a host-to-host interface when you want to use your DAW to receive these messages.

## **Set MIDI channel**

To set the change the MIDI-channel the GR-1 listens to, you will need to enter the configuration screen to do this.

1. Press the “shift” + “Perf” to enter configuration screen
2. Select “MIDI-channel” parameter with the “select” knob (turn & press)
3. Select the desired channel with the “select” knob (turn & press)
4. Press “Escape” button to exit the configuration screen

Turning left completely will turn MIDI off. Note that each of the four parts in the GR-1 has its own assignable MIDI channel. You can set all four at the same time by performing the above, but with the “Shift” button enabled. All available MIDI controls are documented in the chapter “MIDI Control table”.

## **MIDI program changes and banks**

The GR-1 supports MIDI program changes on all of its four parts. For the sake of clarity: the GR-1’s notion of preset bank is not the same as a MIDI program bank. A MIDI program bank is 128 presets; a GR-1 bank is only 8. Sending MIDI program change 0, will activate GR-1 preset 1, bank 1. Sending MIDI program change 8 will activate GR-1 preset 1, bank 2, etc. As you can see the GR-1’s 4 banks are mapped to the program change range [0..31].

## **List Of Tested (USB)MIDI controllers and keyboards**

AKAI MPK25

Alesis Q25

Arturia Beatstep \*1

Arturia Keystep\*1

Arturia Matrixbrute

Casio HT-700

Eowave Ribbon

Joué board

Keith McMillen K-Board Pro 4

Koma Komplex sequencer

Midistart 2

Moog Sub37

Native Instruments 88S MKII

Roli Seaboard Block

Sensel Morph (using the piano keyboard overlay)

StudioLogic MixFace

Synthstrom Deluge

Teenage Engineering OP-1

For proper results with the Arturia controllers you will need to turn off “Transport CC’s” in Arturia’s “MIDI Control Center” program on your PC/Mac.

\*1. Needs GR-1 Firmware v1.2 onwards to function properly.

# Audio Input

There is no audio input on the GR-1 itself, but it can record audio using USB class compliant audio interfaces and dongles.

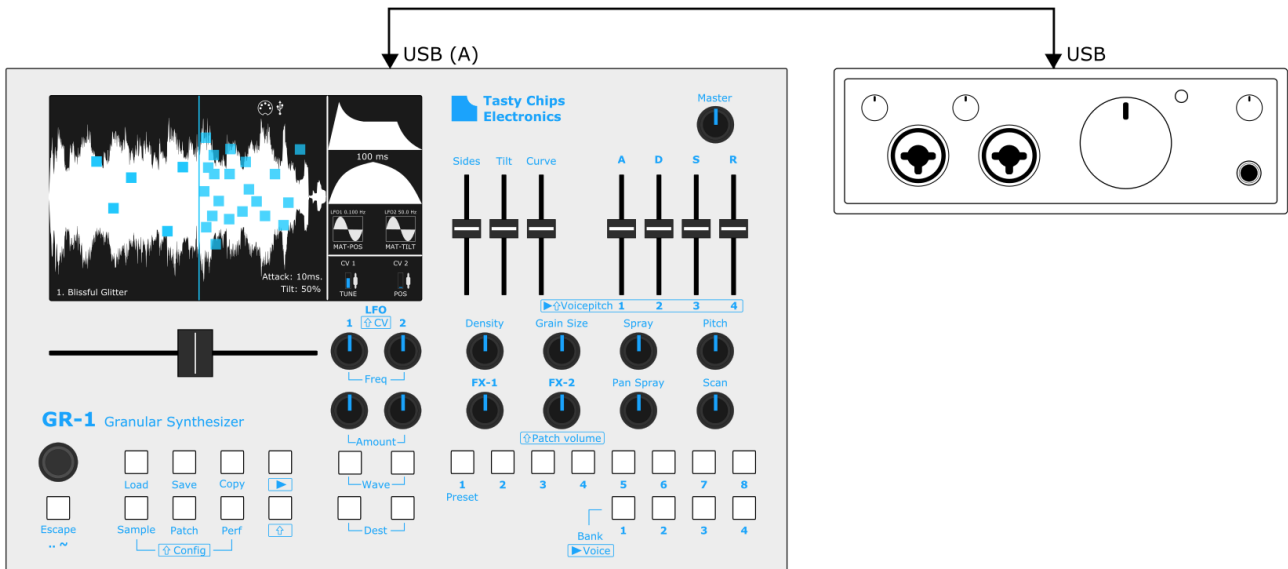

## Configuration

To enter the Sample configuration, press “Shift” and then “Sample”. The configuration parameters can be set with the select knob. Leave this configurations screen with “Escape”. In the top you can see the detected audio interface / sound card. Default it will read:

“Sound card [None found]”. When one is plugged in it should detect it within a second or two:  
“Sound card [BizBaz Audio Frobnicator]”\

## Looping rec

With “looping rec” turned off, the recording of the sample will be a one shot recording. Turn “looping rec” on to do continuous recording/real-time processing.

## Record start mode

You can turn on the ability to record here and select the start point for recording. The following start points are available:

- **Current position:** When pausing the recording, recording will start from that same point when activated again
- **Wiper:** Recording starts from the sample position, when activated
- **Start:** Recording starts from 0.0s, when activated

## Rec level

You can adjust the recording level with this slider here. This goes from 0.0 up to factor 2.0.

## Sample size

The sample size or “recording duration” (in seconds) can be set here. This will take effect immediately. If you did this accidentally, press this preset’s button to undo all unsaved changes to sample and/or patch. Note that resizing only works when *not recording*! This is a design choice, because the GR-1 has no way to know where to record in the buffer once it has resized to something smaller.

## Clear sample

Select and push (used to be Select and turn in firmware versions < 1.5) to create a new sample with the number of seconds set with “Sample size”. If you did this accidentally, press this preset’s button to undo all unsaved changes to sample and/or patch. You can also use Shift+Load when the Sample button is lit to do this.

## Recording samples

To start sampling first see to it that you’ve used the sampling menu described above, and make sure you enabled sampling start position. You can turn on “looping rec” as well if you want to use the GR-1 for live sampling and replay simultaneously. It will then keep looping through its sample buffer until the user manually stops it (press Select).

Hook up your USB sound card and connect it to a sound source.

Now make sure you’re in the main screen and then press Select. A red wiper should appear and should start running forward. If it stays still, then re-plug the USB cable. The GR-1 will now record the incoming sound into the buffer. Sampling is done at 44.1 kHz, 16 bit, mono. Multi-channel sources are converted back to mono.

You can use the play button and scan knob to play through the buffer at different speeds, even backwards. All on play mode functions are available. Including the on-board chord buttons and sliders. All granular parameters and synthesizer parameters are also directly controllable while playing the recording sounds.

To stop recording, press Select once more.

## Supported USB sound cards

Any class-compliant card should work, but some are definitely better than others.

The best:

- ALTO 1604
- Behringer UCA222
- Behringer UFO202 (some white noise)
- Behringer UM2 (please use the XLR input, it needs the mic pre-amp!)
- BOSS SY-1000 guitar synth
- DeLock USB 2.0 Sound Adapter
- EVO4
- EWENT EW3751, USB Audio Adapter 5.1
- Focusrite Scarlett 2i2
- Logitech H390 Wired Headset
- MiniDSP USBStreamer (ADAT, TOSLink -> USB)
- NI Komplete (NOTE: power hungry, please only connect after GR-1 is fully up & running)
- Rocksmith guitar cable
- Roland UA-1EX
- Soundcraft Signature 12
- Sweex USB Sound Card Adapter
- Tascam DR-05X
- Terratec Aureon USB Mini
- Zoom H6
- Zoom R24

Zoom field recorders: We have tested the H4NPro ourselves without external power. But several users have pointed out that they work fine with the GR-1, but external power is recommended. Unfortunately, all of them do suffer from periodic crackles.

These work, but have issues with periodic plops and crackles:

- Sound Blaster Play!3
- Apogee Jam
- Zoom field recorders; H1N, H2, H4, H5
- Elektron Analog Heat (periodic bursts of aliasing reported)

NOTE: The official Raspberry Pi USB driver software causes these crackles. There's not much we can do about it. Eventually the GR-1 may be upgraded to different computer hardware. At the time of writing we've reviewed the first candidate computer board that fixes these issues.

NOTE: The Zoom H6 needs to be set up in “interface” mode for it to be used as audio input device by the GR-1.

Unsupported:

- MOTU Track16

If a sound card is not “USB Audio class compliant”, and requires a special driver for it to work on Windows, Mac, or Linux, then it is not supported by the GR-1. There are no plans for adding support for non-class compliant USB sound cards, as all of them have highly specific driver software making it impossible for us to maintain in the future.





# Importing Samples from external drives

The GR-1 can load samples in different formats from the internal or external (USB) memory.

## Sample Formats

The GR-1 can handle different audio formats and quality, with a maximum of 10 MB (about 2 minutes long). The samples will internally be converted to 44.1KHz 16 bit, mono. The following formats are accepted:

- .wav
- .ogg
- .flac
- .aiff *(However, some .aiff -C files are not supported. Some companies create compressed .aiff files to keep these files exclusive for their own use.)*
- .avr
- .XI

## Loading samples

To load a sample, follow the next steps:

1. Press the “sample” button to enter sample mode, this button will now light up
2. Press the “load” button, you will now enter a menu that looks like the figure below
3. Select the desired sample directory with the “select” knob (turn and press the knob)
4. Select the desired sample with the “select” knob (turn and press the knob)

To **cancel** sample loading and exit the menu press the “Escape” button. The Escape button can also be used to cancel opening a big folder, which would otherwise take a long time.

Note that samples can be played, or previewed in the file selector. For this you’ll need to turn on “Sample previews” in the performance menu.



## Copy samples

To copy sample to another preset, follow the next steps:

1. Press the “sample” button to enter sample mode, this button will now light up
2. Press the “copy” button, the copy button will now blink
3. Press the desired “preset” (with bank and or preset buttons)
4. Press the “copy” button again, the copy button will now stop blinking

To **cancel** after step 2, simply press the “Escape” button.

NOTE: the patch or performance should be explicitly saved for the changes to the destination preset to take effect!

It is possible to record and process (real time) incoming audio. Recorded audio can be saved as a sample.

## Saving samples

To save your sample, follow the next steps:

1. Press the “sample” button to enter “sample mode”, this button will now light up
2. Press the “save” button, you will now enter the save screen
3. Select the desired directory with the “select” knob, (turn the knob)
4. Press save and then name your sample (if you like). See below.
5. Press the “save” button to save.

To **cancel** anytime after step 2, simply press the “Escape” button twice.

**CAUTION: NEVER power down your GR-1 while saving. Data corruption may occur!**

## Naming

0. The default name will show in the text box

1. Turn Select to choose a character in the name with the red cursor
2. Push Select to edit that character. It will now turn blue to indicate edit mode.
3. Turn to scroll through the alphabet and numbers.
4. Push the selected alphanumeric character and go back to character selection mode. Hold down Shift to get capitals.
5. Repeat steps 1..4 until you have written your name.
6. Press “save” to confirm you want to use this name.

**NOTE:** you cannot save samples to /media/internal. This is because the GR-1 has no delete button. So, the GR-1 was designed to not allow arbitrary storage on the internal SD card. Otherwise it could fill up and cause system malfunctions.

**NOTE:** if you want to remove your USB stick or drives you can press Shift + Escape to cleanly eject them. All drives are ejected at the same time.

## Sample Tuning

Samples may not be tuned to the C key. The GR-1 has two ways to tune a sample to the matching note:

- *Analog*, manually using direct on-board controls and your ears.
- *Digital*, using your MIDI keyboard. Most people used to DAW systems will like to get started this way.

*Analog*: For this the “Pitch” knob can be used. It can be tuned one complete octave down or up. To make the tuning process easier, holding down the “escape” button for a couple of seconds activates a tuning sine wave, and the button should light up. Adjust the tuning to match the pitch of the sine wave. Hold down the escape again and the tuning sine wave should deactivate. Note that the tuning sine wave replaces the sub-oscillator, should it be on.

The Pitch knob has a resolution of a couple of cents, because it spans two whole octaves in total. If you want to fine tune down to the last cent, turn the Select knob directly after having turned the Pitch knob.

*Digital*:

1. Enter the patch menu with Shift+Patch
2. Scroll to “Keyboard tuning”
3. Hit the matching note on the MIDI keyboard

Note that both ways may be employed in parallel. This can be confusing, but the analog way allows to set pitch in cents, while the digital way doesn’t. Since firmware 2.2 this combination is visualized when turning the pitch knob.

## Patch Load & Save

When you are tweaking knobs and pressing buttons you are making a “patch”.

You can save, load and copy a patch. A performance consists of 4 banks of 8 presets that are directly accessible. The presets may be overwritten with your own tweaks or even with new patches.

### Saving a patch

To save your patch as a preset, follow the next steps:

1. Press the “patch” button to enter “patch mode”, this button will now light up
2. Press the “save” button, you will now enter the save screen
3. Select the desired directory with the “select” knob, (turn the knob)
4. Press save and then name your patch (if you like), see below.
5. Press the “save” button to save

To **cancel** anytime after step 2, simply press the “Escape” button twice. Note that if you want to remove your USB stick or drives you can press Shift + Escape to cleanly eject them. All drives are ejected at the same time.

### Naming

0. The default name will show in the text box
1. Turn Select to choose a character in the name with the red cursor
2. Push Select to edit that character. It will now turn blue to indicate edit mode.
3. Turn to scroll through the alphabet and numbers.
4. Push keep the selected alphanumeric character and go back to character selection mode.
5. Repeat steps 1..4 until you have written your name
6. Press “save” to confirm you want to use this name

**CAUTION:** NEVER power down your GR-1 while saving. Data corruption may occur! Wait until the display responds to input again before attempting to power down.

**NOTE:** you cannot save patches to /media/internal. This is because the GR-1 has no delete button. So, the GR-1 was designed to not allow arbitrary storage on the internal SD card. Otherwise it could fill up and cause system malfunctions.

## Incremental patch saves

If you want to keep old versions of your patch, do the following:

1. If you haven't done so already: enable the incremental patch saves toggle in the performance menu ("shift"+"perf").
2. Either load a separate patch from USB (patch save to internal storage is *not* allowed), or save your patch under a new name (see above).
3. Hold down "shift", and press "save". This will result in a blinking save button, and possibly a momentarily halted display. A popup should appear with the name of the incremental save patch-0, patch-1, patch-2, etc..

**CAUTION: NEVER power down your GR-1 while saving. Data corruption may occur! Wait until the display responds to input again before attempting to power down.**

## Loading a patch

To load a patch, follow the next steps:

1. Select the preset to load the desired patch on, using the bank and preset buttons.
2. Press the "patch" button to enter "patch mode". This button will now light up.
3. Press the "load" button. You will now enter the load screen.
4. Select the desired patch folder with the "select" knob, (turn and press the knob)

To **cancel** after step 2, simply press the "Escape" button twice.

The name of the loaded patch should now be displayed on the screen. The newly loaded patch is now a preset during this session and may be recalled at your desire by pressing the combination of bank and preset button you selected earlier on.

Note that this applies until the next performance load or reboot. If you wish to store the preset as a part of this performance, you need to explicitly save the performance.

Note that you can also load samples this way. Just select a sample (.wav, .aiff, etc) file instead of a patch folder. This will also import the sample base name, Bla.wav -> "Bla", as the new patch name. (You will need to save the patch or performance to properly store this name as the new preset name.)

## Copy a patch

To copy the current patch to another preset, follow the next steps:

1. Press the “patch” button to enter “patch mode”, this button will now light up
2. Press the “copy” button, the copy button will now blink
3. Select the preset to copy the desired patch to, using the bank and preset buttons
4. Press the “copy” button. The source preset data is now displayed on screen.

To **cancel** after step 2, simply press the “Escape” button twice.

NOTE: the patch or performance should be explicitly saved for the changes to the destination preset to take effect!

## Kill a preset

This clears the currently shown preset. It doesn't modify anything on disk if you don't choose to save afterwards.

1. Press the Patch button.
2. Hold down Shift.
3. Press Load.
4. A popup will now show to ask if you want to kill the preset.
5. Press Escape to cancel or press Select to kill it.

## Patch volume

The patch volume is very useful when it comes to matching volumes of different patches for a (live) performance. The patch volume can be controlled with the “FX-2” knob when the shift button is lit.

# Patch Configuration Menu

## Patch configuration

Press “shift” and then “patch” to enter the “patch configuration” screen. You scroll through the menu by turning the Select knob. Hold shift to speed up scrolling, because this menu is quite long.

## Patch Global Settings

### Name

This allows you to set the name of the preset. This is done character-by-character using the Select knob, or when you connect a computer keyboard, with the keyboard. Turn the Select knob to choose a character to edit. Push to edit. Then turn it to scroll through the letters and numbers. This name will now be used in patch and performance quick saves. Hold down the GR-1’s Shift button to get capital letters.

### Sample mode

This toggles between three modes:

1. Granular: the default playback mode of the GR-1.
2. Audition: just play the sample. It can be pitched like in granular mode. This is useful for previewing sounds, but can also be used for musical purposes since later versions of the v2.1 firmware.
3. Tape mode: Emulates a play head moving over the sample using the “Scan” knob. Use the “Pitch” to set tape slew: how quickly the head picks up movement. Full position modulation and scan looping are supported.

You can always override the sample mode of the current patch with Shift+Play. Pressing play again without shift, will disable the override, and turn it back to the configured sample mode you configured in the menu.

### Spawn mode

This tells the granular engine how to spawn grains when a new note is triggered. There are four options:

1. Gradual: gradually generate grains based on the configured clock
2. Direct: Generate a full cloud as if the granular engine had been running continuously in the background.
3. Direct reset: This does the same as direct mode, but with all grains starting within the spray area. This will boost the bass and the volume of the voice.
4. Recycle: Re-use old grains. This can give silly effects.



Only applies to granular sample mode. Technical note: spawn mode is a consequence of the energy / CPU saving properties of the engine. When a voice is not playing for a while, the granular scheduler is disabled.

### **Grain stealing threshold**

Grain stealing kicks in when the 128 grains per voice are used up. The GR-1's grain stealing is intelligent and results in no crackles or clicks whatsoever. Leave this at 0 to disable grain stealing. This is the default from firmware 2.2 and before. With a high combination of density and grain size the grain scheduler will start oscillating. When the slider is set higher than 0.0 it will gradually start stealing grains. The higher the setting, the more aggressively the stealing will be. This will result in shorter grains, but the grains spread will be quite homogeneous. And the way in which this occurs is quite intuitive and natural.

### **Keyboard tuning**

If your sample is not in the C key, you can easily tune it:

Scroll to this option to highlight it, and then hit the matching note on the MIDI keyboard.

### **ADSR Pile-up**

This toggles between starting the ADSR envelope from 0 or resuming where it started. This applies when repeatedly playing the same note on the keyboard. Especially with long releases, ADSR pile-up is useful. Voice stealing will only occur in extreme cases. But sometimes you want to have abrupt attacks. So, then you can turn this option off.

### **Grain Key Sync**

When this is on, a grain will trigger directly when a note is played. When this is off the grains sequencing is independent from note triggers.

### **Grain Clock Sync**

Turn this on to synchronize the density parameter (the rate at which grains spawn) to the incoming MIDI clock. In this mode the Density knob is used to set multiplier and divider (with Shift pressed).

### **Sample loop confinement**

Turn this on to limit playing of the sample, in both audition/sample and granular mode, to the area defined by the loop start and loop end controls (see below).

### **Resample anti-aliasing**

When this setting is "ON" an anti-aliasing filter will be turned on. This can reduce the amount of voices/polyphony, but increases the audio quality.

## **Granular glide**

Normally the grains that are playing will play until the end of the set “grain size” at the same note pitch of the note that was played when the grain started playing. When the Granular glide setting is “OFF” the grains will be tuned to the notes that are played at that very moment.

If you want the grains to follow the played pitch immediately turn this setting “OFF”. If you have longer grains and want to have a granular-chorus like function that glides between notes. Turn it “ON”.

This feature can also be used to create a swarm like sound where all grains have a different pitch. Just try to wiggle the “Pitch” knob, or use an LFO to modulate TUNE. Set the LFO speed high enough and you’ll get a swarm-like chorus effect. LFO amount can add additional dramatic effect.

## **Patch Scan Settings**

### **Scan Key Sync**

The scanning (scan) through the sample can be synced to a voice trigger/note-on event. When “Scan Key Sync” is “On”, the scan position will reset to the “Play position” on every voice trigger/note-on event. “Legato” will only reset the play position on the first note played.

### **Scan loop confinement**

Turn this on to confine the scanning to the loop area. The loop area is set up with the loop start and loop end controls. When this is off, the entire sample will be scanned through. Note if you have this on, it’s best to disable the option “Sample loop confinement”. Otherwise grains will wrap around this area, mostly resulting in clicks and plops.

### **Scan mode**

The GR-1 scanning movement has three modes:

- Loop
- One shot
- Ping pong

The scan knob influences speed and direction of all these modes.

### **Scan clock sync**

Turn this on to synchronize the scan movement speed to the incoming MIDI clock. In this mode the scan knob is used to set multiplier and divider (with Shift pressed).

# Patch Play Mode Settings

## Responds to play

Toggle this to make this patch responsive to play mode or not. Sometimes it's useful to make a patch exclusively responsive to a MIDI, while other patches are exclusively responsive to play mode.

## Slider base note

This is the base note for play mode. When changing this, turn play off and on again to take effect. C-5 is the native sample replay frequency.

## Free scale

When in play mode, turn this on to allow free sliding pitch: no semitones. Turn it off to enable division of the octave into the scale defined below.

## Play scale

When using the sliders to pitch, choose which notes to enable or disable in the octave. This allows the playing of custom scales.

# Patch FX settings

## FX type

The GR-1 has several built-in effects:

- Delay
- Distortion
- Reducer
- Reverb

Only one of these can be active at a time. Note that the sub-oscillator and filter are not in this list. They can be active simultaneously.

## FX mapping

There are 2 FX knobs on the GR-1: FX1 and FX2. You can map these to the effects, but also to the sub-oscillator and the filter. See the table below for which functions FX1,2 represent when an effect is selected:

filter (all modes)	Frequency [0Hz..20kHz]	Resonance
Sub osc	Freq [-2 octaves .. fundamental]	Amplitude
Delay	Time	Feedback
Distortion	Filter cutoff frequency	Distortion
Reducer	Bit reduction	Sample rate Reduction
Reverb	Time	Amount

Note: if you have mapped an effect (not the filter), you should also change your FX type to this same effect. Otherwise, the knobs will have no effect on the sound!

## Filter mode

You select the filter's mode here: LPF (Low-pass), BPF (Band-pass), HPF (High-pass), or NONE.

## Sub-oscillator

This toggles the sub-oscillator on and off. It can be used to add an extra fundamental to your voice. The sub-oscillator is polyphonic with the correct FX mapping you can control frequency (from -2 octaves to -0) and amplitude with FX1, and FX2, respectively.

## Sub-osc balance

When playing polyphonically, using the sub-oscillator may create a chaotic effect. You can adjust this balance to a lower number to focus more on the bass side of things. It's also possible to focus more on the treble by increasing this number.

# Patch Modulation Settings

## LFO2->Delay sync

Toggle this on to enable the LFO2 period to determine the delay period.

## Cubic LFO amount curve

Toggle between cubic and linear curve for the LFO amount knobs. Cubic mode is useful for vibrato, for instance. This also affects the data entry in the modulation matrix.

## LFO 1 or 2 Sync

When this setting is "ON" the LFO will be synced to the MIDI beat clock, with the selected time division. This setting can be turned on for each individual LFO.

## LFO 1 or 2 Key Sync

Each LFO can individually be synced to a voice trigger/note-on event. When this feature is "ON", the LFO wave will reset to the beginning of the waveform on every voice trigger/note-on event.

## LFO 1 or 2 max freq

This sets the maximum frequency of LFO1 and LFO2, respectively. Range starts at 0.01 Hz and goes up to 100 Hz. This can be used to gain more precision in the low ranges. For instance, if you have an LFO period of an hour and want to set it to 61 minutes. The default is 50 Hz.

## Mod Wheel -> LFO 1 or 2

Enable this to amplify the entire MOD matrix row (LFO1 or LFO2) using your MIDI controller's mod wheel. Note that the default cutoff function of the mod wheel in earlier versions is now gone!

## LFO1->2 Cross Modulation

This is the amount of cross modulation between LFO1 and LFO2. LFO1 modulates the frequency of LFO2.

## LFO 1 or 2 Quantization

This quantizes the phase of the respective LFO unit. 1 denotes OFF, 1024 denotes maximum. Maximum phase quantization will limit the output of the LFO unit to just 2 states.

## **Modulation Matrix**

The modulation matrix allows you to set multiple modulation destinations per modulation source (LFO1, LFO2, CV1, CV2, Aftertouch, Timbre, Lift, Velocity, Pitch [from last note!]), instead of just the one-to-one routing available in the main screen.

The matrix is split into 9 rows in the menu. Push select once to enter the row. Turn to select a cell for editing. Then turn to increase or decrease value. The minimum is -1.0, and the maximum is +1.0. You can also use the horizontal slider to set values more quickly. Negative values allow LFO waveforms to be inverted. Tap again to leave edit mode, and hit Escape to exit the row. Escape also works to exit edit mode.

If you desire more precision when dialing in values in the matrix, use the “Cubic LFO amount curve” toggle.

If you change a value the main screen will recognize and display “MAT-” instead of a single destination. Tapping the destination button will remove the MATRIX status.

An important thing to keep in mind is that the GR-1 by default operates the LFO’s and CV’s in one-to-one mode. Only one modulation destination is possible per matrix row. Hold down one of the LFO Dest buttons for a while and they’ll be lit and you’ll enter matrix mode for the LFO amount knobs. No longer will matrix cells be cleared once you turn the LFO amount knobs or press the LFO Dest buttons. This makes matrix editing much faster also in the main screen. This matrix/one-to-one toggle is a system wide setting that resets back to default at every boot.

Note that the MPE aftertouch, timbre, lift, velocity, and pitch modulation sources cannot drive tuning, or grain window destinations. There is only one stereo filter for each multitimbral part. This implies that cutoff is also only available on global modulation sources and on pitch. Modulation from pitch to cutoff is done by taking the last played or playing key. A tuning destination was left out, because MPE already has pitch bend per note, and we felt it could lead to confusion.

**For the modulation sources aftertouch, timbre, lift, velocity and pitch to take effect, MPE mode should be enabled in the performance menu.**

Mod matrix cells can also be changed directly via MIDI CC. See the CC table for details. Note that MPE matrix cells are not available as CC, for the simple reason there are not enough CC’s available any more.

## **MPE Position clipping**

Toggles clipping if MPE modulates sample position. In some musical use-cases clipping is desirable, in others it isn’t.

# Patch Keyboard

## Keyboard split 1,2

The keyboard can be split in 3 areas (0, 1, and 2) , using 2 splits options. Split 2 should always be at least as high as split 1 on the keyboard.

Area 0: left of split 1

Area 1: right of split 1, and possibly left of split 2

Area 2: right of split 2

If splits are off, everything is Area 0.

## Area 0..2 – Pos offset

This allows you to add a sample position to a keyboard area. It is added to the sample position generated from the matrix and by the position slider.

## Area 0..2 – Keyboard -> Pos

This allows you to map keyboard note to sample position. It is added to the sample position generated from the matrix and by the position slider. This can be used to step through the sample's gradients and/or parts.

## Area 0.1 – Pitch

Toggles pitch on and off. Useful if you want to have only sample position control in a keyboard area.

# Performances & Performance Configuration

A set of 32 (max) patches/presets + global settings is what we call a performance. MIDI channel and hardware settings etc. can be configured for an individual performance. You can load and save performances to/from both internal storage and to/from USB drive.

## Configuration

To enter the performance configuration press “Shift” and then “Perf”. The configuration parameters can be set with the select knob. Leave this configurations screen with “Escape”.

**The firmware version can be found here in this menu: look in the top right.**

## Midi Channels

Since the GR-1 is multitimbral it allows you to set the MIDI channel for each of the four parts. Turn completely to the left to turn off MIDI handling for this part. Hold down “Shift” to set all four parts to the same channel.

## LED Brightness

Controls the brightness of the LED buttons.

## Potentiometer Setpoints

When “ON” the potmeters/knobs of a saved patch are locked, until you turn/slide past the saved set point. From v1.2 and up it, setpoints will also be displayed numerically (30.4% for instance), under the lock icon. So that you know which side you have to turn to, to activate the control.

## Direct shift

When this is on, you’ll have to keep Shift pressed to access secondary functions like the voice sliders or quick save. When this is off, the Shift button behaves like a toggle.

## ADSR Slider mode

The ADSR sliders can be just how they were intended, but also to control the individual volumes of the four play mode voices (“Voice vol”), or to control the individual volumes of the four parts (“Part vol”).

## Velocity Curve

Keyboard velocity sensitivity: Choose between sqrt (square root) and linear here. Square root is the default, and used by most well-known synths.



## **Load sample: convert to 44.1**

Turn this on to force the GR-1 to convert every imported sample to native 44.1 kHz sample rate. Loaded samples that are already 44.1 kHz are not modified.

## **MIDI CC updates visuals**

Since MIDI CC's can happen a lot if you're sequencing the GR-1 via MIDI. It may be convenient to turn the visual updates off. Turn it on if you want to keep track of the CC activity. May be useful for diagnostics.

## **Patch switch -> stop grains**

When switching patches grains are stopped. Clicks may be heard. If you turn this off, grains will keep playing: no clicks, but there may be old/long grains in other parts of the sample. This is nice for smooth transitions from patch to patch.

## **Pitchbend range**

Pitchbend range in semitones. Note that in previous firmwares ( $\leq 2.3$ ), the MPE toggle forced the range to 48 semitones, which is ideal for the Roli Seaboard, but other MPE controls may be more suited to smaller ranges.

## **DSP Metering**

Toggles a DSP processing bar in the main display. Full width means 100% CPU usage. Audio dropouts will occur already around 90%. Can be used to see how the GR-1 reacts to larger spray, bigger samples, larger grains, higher density, and higher polyphony.

## **MPE**

Turn on MPE support. This effectively supersedes MIDI channel selection. This will turn on an enormous pitch bend range, which is not recommended for normal MIDI input devices.

## **File selector: Sound previews**

Very big sample files can cause the file selector to slow down to a crawl. This is because the samples are loaded in and then played, and the code was not optimized yet. In 1.2.1 we added a switch to turn them off. This is off by default.

## **Incremental patch saves**

Save patches like "Patch", "Patch-1", "Patch-2", etc. This is useful to preserve intermediate steps in your work. Use patch quick save (Shift+Save) to make use of this option. If your patch is new (not yet saved), then you'll first need to save it (just the Save button, without Shift) manually.

## Send precision CC

When one of the physical controls of the GR-1 is moved, send 14 bit NRPN's instead of just the normal 7 bit CC's. This affects MIDI OUT. MIDI OUT can only be used using a USB host-to-host interface.

## Check Firmware Upgrade

This will check for firmware updates on the attached USB stick/drive and allow you to update from here. This is the same as what happens on boot with an attached USB stick with firmware updates on it. It has the added benefit of also checking for updates from the tasty chips site if the LAN cable is plugged in. Select and push again to check for new firmware. An online firmware upgrade has priority over one on the USB stick. Please keep this in mind.

## On board chord toggle mode

Normally the play mode toggles voices on/off with the bank 1-4 buttons. Turn this off and the voices will only play when the buttons are pressed.

## Saving a Performance

To save your performance, follow the next steps:

1. Press the "performance" button to enter "performance mode", this button will now light up
2. Press the "save" button, you will now enter the save screen
3. Select the desired directory with the "select" knob, (turn the knob)
4. Internal memory: select one of the 6 folders (50 on later models), press select to enter the folder, and press save
5. External memory (USB disk): select a folder (keep in mind that everything that is inside the performance will be saved, so you might want to make empty folders on your disk) then press save.

To **cancel** anytime after step 2, simply press the "Escape" button twice.

**CAUTION:** NEVER power down your GR-1 while saving. Data corruption may occur!

**NOTE:** Use your mac/pc to create performance folders on your USB disk before saving performances. A "performance save" will save 32 patch folders + a file `performance.grp` in the selected folder.

**NOTE:** Saving a performance takes time. It's only recommended for starting new performances or copying from internal to USB or vice-versa. If you're editing a performance, quick save is recommended.

**NOTE:** you *can* save performances to /media/internal. This is because there are only a limited amount of folders in /media/internal to which you can store performances, and a performance itself has a fixed maximum size.

**NOTE:** if you want to remove your USB stick or drives you can press Shift + Escape to cleanly eject them. All drives are ejected at the same time.

### **Performance quick save**

To quickly save the performance you're editing:

1. Press the "performance" button to enter "performance mode", this button will now light up
2. Press "shift" together with "Save"
3. The Save button will now blink for a second or two

**CAUTION:** NEVER power down your GR-1 while saving. Data corruption may occur! Wait until the display responds to input again before attempting to power off.

**TIP:** quick save your performance to quickly store the performance menu settings to permanent memory. If you do this with the default performance (that loads when starting), you'll start up next time with these settings.

### **Loading a performance**

To load a performance, follow the next steps:

1. Press the "Perf" button to enter "performance mode", this button will now light up
2. Press the "load" button, you will now enter the load screen
3. Select the desired performance folder (turn the "select" knob", and press it), or select the performance.grp in the root of your USB drive, if you saved it there.

To **cancel** anytime after step 2, simply press the "Escape" button twice.

### **Initializing a performance**

Using this function you start from a bunch of samples of your choice. This loads a directory filled with samples into the preset slots. This function is operated as the loading but with Shift pressed when pressing load.

1. Press the “load” button, you will now enter the load screen. [This procedure doesn’t care about whether the Sample, Patch, or Perf buttons are lit. But it’s useful to have Sample or Patch lit, as that will show actual sample files in the file chooser. Perf mode will filter them out.]
2. Use the Select knob to enter the desired folder filled with samples.
3. Hold down Shift and press Load.

This loads the samples in the selected folder into the preset slots. Default patch parameters and performance menu settings are used.

### **Copy preset to “all”**

Copy a single preset or that preset template to all the preset slots in the performance. We like to call the preset’s parameters (without sample) “template”.

1. Press the Perf button.
2. Select the preset you want copied.
3. Press Copy.
  1. Just pressing “Copy” without Shift will copy the entire preset.
  2. Holding Shift and pressing Copy will copy the template.
4. A popup will ask if you want to proceed. Press Select to do so, or Esc to cancel.
5. If you pressed Select, the preset (or its template) is copied to all the presets in the performance.

## Timbrality

Since firmware 2.0 the GR-1 can operate either monotimbral, which means it plays a single patch, or multitimbral, which means it plays multiple patches at the same time. By default it runs in monotimbral mode.

### Entering multitimbral mode

You can add patches to the mix using Shift + preset buttons 1, 2, 3, and 4. The sample display will automatically be split in 4 parts, indicating you're now running multitimbral mode. The new patch can be immediately heard.

You can now just switch patches using the preset buttons, control the patch parameters like you're used to. The knobs change the patch parameters of the currently highlighted ("focused") part. The last part activated is displayed in a lighter shade of grey.

### Focus on a part

Since firmware 2.1, you can use the Select knob to scroll and focus on a part of your choosing.

Pressing this button combination (Shift + preset 1, 2, 3, or 4) again on an active part will remove the preset from the part. When only a single patch is left, the display goes back to monotimbral mode, displaying only a single sample.

NOTE: The same part cannot be present in multiple parts. The GR-1 will refuse to add the same patch twice. Since firmware 2.3 it will show this with a popup.

### MIDI configuration

Patches can respond to different MIDI channels, and can be sensitive to play mode. This can be done in the patch menu. Which makes multitimbral mode so flexible. This way you can even record and granulate a live sample on one part and play chords and solos on other patches, all at the same time.

NOTE: Increasing the number of parts will yield higher polyphony. Restrictions to polyphony apply and are outlined in the next section.

# Polyphony

This section explains the GR-1's forms of polyphony, the voice stealing algorithm, the grain window, and how to make the best of them.

## Forms of polyphony

The GR-1 has two forms of polyphony:

- *Grain polyphony*: 128 grains per voice
- *Voice polyphony*: corresponding to playing notes: 11 voices at the time of writing.
- 

## Voice timbre

A voice may have anywhere from 0 to 128 grains playing at any time. This allows the flexibility to have a single grain playing (sporadically) up to a massive "cloud" of grains. No amount of playing notes will cause the amount of grains to be modified by the engine. The timbre of the voice will be kept intact as much as possible.

## Note hold

The GR-1 supports the MIDI hold CC. Since version 2.1 this acts like the standard hold function, instead of just holding previously playing notes. That is, all new notes will remain playing even if your fingers were lifted from the keyboard. This remains this way until hold is turned off again.

## Voice stealing

When the GR-1 reaches maximum voice polyphony and the user presses yet more notes on the keyboard, it will choose to abruptly remove the oldest playing note, preferably already in release, that is not being held (by the hold CC explained above). It also makes choices based on the position of the notes on the keyboard in relation to each other. This should make note polyphony as full and responsive as possible. Voice stealing can be delayed significantly by using ADSR pile-up mode in the patch menu.

## Grain stealing

When the maximum amount of grains per voice (128) is reached, the grain scheduler will stall until grains have reached their end. This results in an oscillation effect where there's a big bunch of grains in one place and nothing elsewhere. Grain stealing remedies this effect. It will steal grains in a way that is inaudible to the user: no crackles or clicks. The only drawback is that it (logically) shortens grains. This depends a lot on the Grain stealing threshold setting. See the patch menu.

## **Audio, and avoiding drop-outs**

When pushing the GR-1's engine, audio dropouts can occur. It is important to remember that granular synthesis is random in nature. Too much and too scattered access to sample memory will result in a high strain on the engine..

- Maximum voice polyphony is caused by long envelope release and fast playing on the keyboard.. Beware, the GR-1 allows almost 50 second long envelope release!
- Maximum grain polyphony is caused by high grain size and density.
- High spray and long samples will cause scattering of sample memory access.

A suitable comparison is cooking with only 4 burners on your stove, but having a lot of pans around. The more powerful your hardware is, the more burners you have. The larger the sample, the higher the spray, and polyphony, the more pans you'll have around. You'll have to swap out many pans many times which causes slow downs.

The combination of the above factors can cause audio dropouts. The solution is to be aware of them, and apply some practical knowledge:

- If you desire long releases and many playing notes: consider limiting spray and/or choosing shorter samples. Alternatively, choose a short envelope release and use the built-in delay effect or use an external reverb that can generate long releases.
- With longer grains, it's often enough to have a density of 100 grains per second.
- The on-board play mode can be adequate for drones, by just using 4 voices.
- Anti-aliasing may be turned off. This is not recommended, but the aliasing sounds can be used creatively, in some cases.

## **Master volume and patch volume**

When note polyphony increases the total volume will also increase. There is no compression on the end mix, so it will start hard clipping the output. So keep in mind that you can lower the volume with the master knob.

Note firmware 1.4.2 onwards has higher volume than before. Since firmware 2.2 the patch volume can go a lot higher than before, and will cause similar clipping if not handled with care.

## **Grain window modification**

For the sake of simplicity and optimization, there is only a single global grain window per part. This means that any change to the window while it is playing might result in crackles. However, if the change is gradual and the window shape is convex (that means not pointy), the crackles will be minimal.

## Temperature and the internal fan

When the strain on the engine increases the physical power of the computer in the GR-1 also increases. Which, after a while, leads to higher temperatures. At about 70 degrees C it will turn on the fan, in order to keep cool. This happens in warmer climates (room temperatures > 25C) and continued strain on the engine for a couple of minutes.

At the time of writing the GR-1 is equipped with a Raspberry Pi 3, but in the future more powerful boards can be used to replace it. Leading to an overall cooler system with higher polyphony.

## Menu screens

Related to temperature and dropouts is also the screen you are using. The main screen has many animated components, so will stress the system more. A menu screen uses less CPU and GPU horsepower so it will run cooler and dropouts will be less likely. If you've exhausted all other options, this may be useful to know.

On board controls		
Controls	Screen/mode	Function in screen
Position slider	Main	Sample position
Position slider	Menus	Cell select / toggle, slider value
Escape button	All, except main	Escape to previous naming/saving step or screen
Escape button (keep pressed)	All	Tuning oscillator
Shift + Escape	All	Eject all USB drives. Shift should be explicitly pressed. Toggle mode ignored!
Play	All	Toggle play mode
Shift + Play	All	Sample audition mode
Sample	All	Set sample IO mode, escape to main screen
Shift + Sample	All	Enter sampling menu
Patch	All	Set patch IO mode, escape to main screen
Shift + Patch	All	Enter patch menu
Performance	All	Set performance IO mode, escape to main screen
Shift + performance	All	Enter performance menu
Load	All	Enter load menu for selected IO mode (sample, patch, or performance)



Shift + Load	All	Kill sample, patch, or performance. Shift should explicitly be pressed. Toggle mode is ignored!
Save	All	Enter save menu for selected IO mode (sample, patch, or performance)
Save	Save file dialog	Confirm overwrite
Shift + Save	Main	Quick save the current sample, patch of performance
Copy	All	Copy selected IO item (sample, or patch) to buffer. If blinking paste from buffer to current patch/sample.
Copy [when Perf button is lit]	All	Copy preset to all presets, including sample.
Shift + Copy [when Perf button lit]	All	Copy patch [WITHOUT SAMPLE] to all presets!
Wave1, Wave2	All	Set next LFO waveform for LFO1, or LFO2
Shift + [Wave 1, or Wave2]	All	Toggle LFO AUX waveform recording (REC<->STOP)
Dest1, Dest2	All	Set next destination for LFO1, or LFO2
Dest1, Dest2 (hold down)	All	Toggle between single source-dest mode and matrix mode. Both buttons will light up.
Preset 1..8	All	Set current part to patch 1..8 within current bank, return to main screen.
Shift + Preset 1..4	All	Toggle part 1..4 on/off
Bank 1..4	All (play mode OFF)	Select bank, patch will change directly
Bank 1..4	All (play mode ON)	Toggle or trigger voice 1..4
Density	All (MIDI grain clock OFF)	Set density
Density	All (MIDI Grain clock ON)	Set MIDI grain clock MUL
Density + Shift	All (MIDI Grain clock ON)	Set MIDI grain clock DIV
Grain size	All	Set grain size
Spray	All	Set spray area
Pitch (aka Tune)	All, except tape mode	Tune -1 .. +1 octave
Pitch (aka Tune)	Tape mode	Tape slew rate
FX1	All	Set FX1 control as mapped by FX mapping in patch menu
FX2	All	Set FX2 control as mapped by FX

		mapping in patch menu
Shift + FX2	All	Patch volume
Pan spray	All	Set pan spray
Scan	All, except audition mode	Set scan speed
Scan	Scan clock sync = ON	Set scan clock multiplier
Shift + Scan	Granular mode	Set forward/reverse direction bias
Shift + Scan	Scan clock sync = ON	Set scan clock divider
Sides	All	Set grain window sides
Sides + Shift	All	Set loop start
Tilt	All	Set grain window tilt
Curve	All	Set grain window curve
Shift + Curve	All	Set loop end
Attack	All	Set ADSR attack
Shift + Attack	All (Play mode ON)	Set Voice 1 pitch
Decay	All	Set ADSR decay
Shift + Decay	All (Play mode ON)	Set Voice 2 pitch
Sustain	All	Set ADSR sustain
Shift + Sustain	All (Play mode ON)	Set Voice 3 pitch
Release	All	Set ADSR release
Shift + Release	All (Play mode ON)	Set Voice 4 pitch
Master	All	Master volume
Select button	Main	Toggle record (if enabled in sampling menu!)
Select button	Menus	Select/deselect row, and cell (when row selected)
Select knob (turn)	Main (monotimbral)	Fine adjust loop start / loop end, and various other knobs, when previously touched
Select knob (turn)	Main (multitimbral)	Scroll to parts in order to apply focus
Select knob (turn)	Menus	Scroll through rows or cells
Shift + Select knob (turn)	All	Scroll or adjust at x10 speed
Freq1,2	All	Adjust LFO speed
Freq1,2	MIDI LFO Clock sync ON	Adjust LFO clock multiplier
Shift + Freq1,2	MIDI LFO Clock sync ON	Adjust LFO clock divider
Amount1,2	All	Adjust LFO amount



## MIDI Control Change (CC) table

MIDI msg.	GR-1 parameter	Command / CC	Value	Range/description	Control curve
Pitch bend	Pitch bend	-	0 – 16383	see CC 60 (pitchbend range)	2^n
Program change	Select patch	-	0 – 31	MIDI PGM 0..7 -> Preset 1..8, Bank 1; MIDI PGM 8..15 -> Preset 1..8, Bank 2; MIDI PGM 16..23 -> Preset 1..8, Bank 3; MIDI PGM 24..31 -> Preset 1..8, Bank 4;	
Note on	Note on	-	0-127		Linear (volume)
Note off	Note off	-	0-127		
CC	MOD wheel	1	0 - 127	Cutoff (additive) 0..10 kHz	linear
CC	position	2	0 – 127	Start .. end of sample	linear
CC	density	3	0 - 127	0.1 .. 1000 grains/s	cubic
CC	grain size	4	0 - 127	5 ms .. 5000 ms	cubic
CC	spray	5	0 - 127	0 .. full sample size	linear
CC	NRPN value MSB	6	0 – 127		-
CC	GM Volume	7	0 - 127	Preset volume	cubic
CC	cutoff	8	0 - 127	0 Hz .. 20 kHz	cubic
CC	resonance	9	0 - 127	127: just below self-oscillation	linear
CC	panspray	10	0 - 127	mono..total stereo	linear
CC	scan	11	0 - 127	-2x .. +2x replay speed	linear
CC	Window – Sides	12	0 - 127	0..1 (no sides .. no center)	linear
CC	Window - tilt	13	0 - 127	-1..+1 (left .. right)	linear
CC	Window – curve	14	0 - 127	-1..+1 (hollow..fat)	linear
CC	LFO 1 waveform	15	0 – 3	0:SINE, 1:RAND, 2:SAW, 3:SQR	
CC	LFO 2 waveform	16	0 – 3	0:SINE, 1:RAND, 2:SAW, 3:SQR	
CC	LFO 1 frequency	17	0 - 127	50 mHz .. 50 Hz	cubic
CC	LFO 1 amount	18	0 - 127		linear
CC	LFO 2 frequency	19	0 - 127	50 mHz .. 50 Hz	cubic
CC	LFO 2 amount	20	0 - 127		linear
CC	CV1 amount	21	0 - 127		linear
CC	CV2 amount	22	0 - 127		linear
CC	Attack time	23	0 - 127	0 ms .. 23 s (linear)	cubic (special)
CC	Decay time	24	0 - 127	0 ms .. 45 s (exp)	cubic (special)
CC	Sustain amplitude	25	0 - 127		linear
CC	Release time	26	0 - 127	0 ms .. 45 s (exp)	cubic (special)
CC	LFO1 destination	27	0-10	0:TUNE, 1:POS, 2:SPRAY, 3:SIZE, 4:DENS, 5:CUTOFF, ..	

CC	LFO2 destination	28	0-10	0:TUNE, 1:POS, 2:SPRAY, 3:SIZE, 4:DENS, 5:CUTOFF, ..	
CC	CV1 destination	29	0-10	0:TUNE, 1:POS, 2:SPRAY, 3:SIZE, 4:DENS, 5:CUTOFF, ..	
CC	CV2 destination	30	0-10	0:TUNE, 1:POS, 2:SPRAY, 3:SIZE, 4:DENS, 5:CUTOFF, ..	
CC	LFO1 key sync	31	0-1		
CC	LFO2 key sync	32	0-1		
CC	MOD wheel LSB	33	-	UNUSED	
CC	LFO1 clock sync	34	0-1(+)	0:OFF, >0:ON	
CC	LFO2 clock sync	35	0-10	0:OFF, >0:ON	
CC	Patch volume	36	0 - 127	[0.0 .. 10.0]	cubic
CC	Grain Fwd/Rev bias	37	0-127	-1.0 .. +1.0 (NOTE: this used to be antialias toggle in firmware <2.2)	linear
CC	NRPN value LSB	38	0 - 127		-
CC	Master volume	39	0 - 127	0.0 .. 1.00	cubic
CC	MOD LFO1-TUNE	40	0-127	-1.0 .. +1.0	linear
CC	MOD LFO1-POS	41	0-127	-1.0 .. +1.0	linear
CC	MOD LFO1-SPRAY	42	0-127	-1.0 .. +1.0	linear
CC	MOD LFO1-SIZE	43	0-127	-1.0 .. +1.0	linear
CC	MOD LFO1-DENS	44	0-127	-1.0 .. +1.0	linear
CC	MOD LFO1-CUTOFF	45	0-127	-1.0 .. +1.0	linear
CC	MOD LFO2-TUNE	46	0-127	-1.0 .. +1.0	linear
CC	MOD LFO2-POS	47	0-127	-1.0 .. +1.0	linear
CC	MOD LFO2-SPRAY	48	0-127	-1.0 .. +1.0	linear
CC	MOD LFO2-SIZE	49	0-127	-1.0 .. +1.0	linear
CC	MOD LFO2-DENS	51	0-127	-1.0 .. +1.0	linear
CC	MOD LFO2-CUTOFF	52	0-127	-1.0 .. +1.0	linear
CC	MOD CV1-TUNE	53	0-127	-1.0 .. +1.0	linear
CC	MOD CV1-POS	54	0-127	-1.0 .. +1.0	linear
CC	MOD CV1-SPRAY	55	0-127	-1.0 .. +1.0	linear
CC	MOD CV1-SIZE	56	0-127	-1.0 .. +1.0	linear
CC	MOD CV1-DENS	57	0-127	-1.0 .. +1.0	linear
CC	MOD CV1-CUTOFF	58	0-127	-1.0 .. +1.0	linear
CC	MOD CV2-TUNE	59	0-127	-1.0 .. +1.0	linear
CC	Pitchbend range	60	0 - 127	0 -> -1 octave, 64 -> original pitch, 127 -> +1 octave	2^n
CC	MOD CV2-POS	61	0-127	-1.0 .. +1.0	linear
CC	MOD CV2-SPRAY	62	0-127	-1.0 .. +1.0	linear
CC	MOD CV2-SIZE	63	0-127	-1.0 .. +1.0	linear
CC	Sustain pedal	64	0-127	0: release held notes, >=64: hold playing notes	
CC	MOD CV2-CUTOFF	65	0-127	-1.0 .. +1.0	linear
CC	Scan key sync	66	0-1		
CC	Tune	67	0 - 127	-1 .. +1 octave	2^n

CC	MOD CV2-DENS	68	0-127	-1.0 .. +1.0	linear
CC	REC(ord sample)	69	0-127	0: stop, >=1: start	
CC	MOD LFO1-SIDES	72	0-127	-1.0 .. +1.0	linear
CC	MOD LFO1-TILT	73	0-127	-1.0 .. +1.0	linear
CC	MOD LFO1-CURVE	75	0-127	-1.0 .. +1.0	linear
CC	MOD LFO2-SIDES	76	0-127	-1.0 .. +1.0	linear
CC	MOD LFO2-TILT	77	0-127	-1.0 .. +1.0	linear
CC	MOD LFO2-CURVE	78	0-127	-1.0 .. +1.0	linear
CC	MOD CV1-SIDES	79	0-127	-1.0 .. +1.0	linear
CC	MOD CV1-TILT	80	0-127	-1.0 .. +1.0	linear
CC	MOD CV1-CURVE	81	0-127	-1.0 .. +1.0	linear
CC	MOD CV2-SIDES	82	0-127	-1.0 .. +1.0	linear
CC	MOD CV2-TILT	83	0-127	-1.0 .. +1.0	linear
CC	MOD CV2-CURVE	84	0-127	-1.0 .. +1.0	linear
CC	MOD TIMBRE-DENS	85	0-127	-1.0 .. +1.0	linear
CC	MOD TIMBRE-CUTOFF	86	0-127	-1.0 .. +1.0	linear
CC	MOD TIMBRE-TUNE	87	0-127	-1.0 .. +1.0	linear
CC	MOD TIMBRE-POS	88	0-127	-1.0 .. +1.0	linear
CC	MOD TIMBRE-SPRAY	89	0-127	-1.0 .. +1.0	linear
CC	MOD TIMBRE-SIZE	90	0-127	-1.0 .. +1.0	linear
CC	MOD TIMBRE-SIDES	91	0-127	-1.0 .. +1.0	linear
CC	MOD TIMBRE-TILT	92	0-127	-1.0 .. +1.0	linear
CC	MOD TIMBRE-CURVE	93	0-127	-1.0 .. +1.0	linear
CC	MOD VELOCITY-DENS	94	0-127	-1.0 .. +1.0	Linear
CC	MOD VELOCITY -CUTOFF	95	0-127	-1.0 .. +1.0	Linear
CC	MOD VELOCITY -TUNE	96	0-127	-1.0 .. +1.0	Linear
CC	MOD VELOCITY -POS	97	0-127	-1.0 .. +1.0	Linear
CC	MOD VELOCITY -SPRAY	103	0-127	-1.0 .. +1.0	Linear
CC	MOD VELOCITY -SIZE	104	0-127	-1.0 .. +1.0	Linear
CC	MOD VELOCITY -SIDES	105	0-127	-1.0 .. +1.0	Linear
CC	MOD VELOCITY -TILT	107	0-127	-1.0 .. +1.0	Linear
CC	MOD VELOCITY -CURVE	108	0-127	-1.0 .. +1.0	linear
CC	MOD AFTER -DENS	109	0-127	-1.0 .. +1.0	Linear
CC	MOD AFTER -CUTOFF	110	0-127	-1.0 .. +1.0	Linear
CC	MOD AFTER -TUNE	111	0-127	-1.0 .. +1.0	Linear
CC	MOD AFTER -POS	112	0-127	-1.0 .. +1.0	Linear
CC	MOD AFTER -SPRAY	113	0-127	-1.0 .. +1.0	Linear
CC	MOD AFTER -SIZE	114	0-127	-1.0 .. +1.0	Linear
CC	MOD AFTER -SIDES	115	0-127	-1.0 .. +1.0	Linear
CC	MOD AFTER -TILT	116	0-127	-1.0 .. +1.0	Linear
CC	MOD AFTER -CURVE	117	0-127	-1.0 .. +1.0	linear
CC	NRPN Par LSB	98	0 – 127		-
CC	NRPN Par MSB	99	0 – 127		-

CC	RPN Par LSB	100	0 – 127		-
CC	RPN Par MSB	101	0 – 127		-
CC	Note pressure LSB	102	0-127		
CC	MPE timbre LSB	106	0-127		
CC	All sound off	120	-	All notes off and cut sound	-
CC	All sound off	123	-	All notes off	-
CC	OMNI off	124	-	OMNI mode off, accept commands only on 1 channel	-
CC	OMNI on	125	-	OMNI mode on, accept commands on all channels	-
CC	MOD LIFT -DENS	128	0-127	-1.0 .. +1.0	Linear
CC	MOD LIFT -CUTOFF	129	0-127	-1.0 .. +1.0	Linear
CC	MOD LIFT-TUNE	130	0-127	-1.0 .. +1.0	Linear
CC	MOD LIFT-POS	131	0-127	-1.0 .. +1.0	Linear
CC	MOD LIFT-SPRAY	132	0-127	-1.0 .. +1.0	Linear
CC	MOD LIFT-SIZE	133	0-127	-1.0 .. +1.0	Linear
CC	MOD LIFT-SIDES	134	0-127	-1.0 .. +1.0	Linear
CC	MOD LIFT-TILT	135	0-127	-1.0 .. +1.0	Linear
CC	MOD LIFT-CURVE	136	0-127	-1.0 .. +1.0	linear
CC	Enable part	138	0..3	Part number = value + 1 (multitimbrality)	
CC	Focus part	139	0..3	Focus on part 1..4 (only one is highlighted) (multitimbrality)	
CC	Scan part 1..4	140-143	0-127	-2.0 .. +2.0	linear
CC	Map channel to part 1..4	166-169	0-16	0 OFF, >0 midi channel	
CC	Disable part	174	0..3	Part number = value + 1 (multitimbrality)	
CC	Map preset to part 1..4	175-178	0..31		
CC	MOD PITCH -DENS	183	0-127	-1.0 .. +1.0	Linear
CC	MOD PITCH -CUTOFF	184	0-127	-1.0 .. +1.0	Linear
CC	MOD PITCH -TUNE	185	0-127	-1.0 .. +1.0	Linear
CC	MOD PITCH -POS	186	0-127	-1.0 .. +1.0	Linear
CC	MOD PITCH -SPRAY	187	0-127	-1.0 .. +1.0	Linear
CC	MOD PITCH -SIZE	188	0-127	-1.0 .. +1.0	Linear
CC	MOD PITCH -SIDES	189	0-127	-1.0 .. +1.0	Linear
CC	MOD PITCH -TILT	190	0-127	-1.0 .. +1.0	Linear
CC	MOD PITCH -CURVE	191	0-127	-1.0 .. +1.0	Linear
CC	MOD PITCH -AMP	192	0-127	-1.0 .. +1.0	Linear
CC	MOD PITCH -PANSPRAY	193	0-127	-1.0 .. +1.0	Linear
CC	MOD LFO1-AMP	194	0-127	-1.0 .. +1.0	Linear
CC	MOD LFO1-PANSPRAY	195	0-127	-1.0 .. +1.0	Linear
CC	MOD LFO2-AMP	196	0-127	-1.0 .. +1.0	Linear
CC	MOD LFO2-PANSPRAY	197	0-127	-1.0 .. +1.0	Linear
CC	MOD CV1-AMP	198	0-127	-1.0 .. +1.0	Linear
CC	MOD CV1-PANSPRAY	199	0-127	-1.0 .. +1.0	Linear

CC	MOD CV2-AMP	200	0-127	-1.0 .. +1.0	Linear
CC	MOD CV2-PANSPRAY	201	0-127	-1.0 .. +1.0	Linear
CC	MOD TIMBRE-AMP	202	0-127	-1.0 .. +1.0	Linear
CC	MOD TIMBRE - PANSPRAY	203	0-127	-1.0 .. +1.0	Linear
CC	MOD AFTER-AMP	204	0-127	-1.0 .. +1.0	Linear
CC	MOD AFTER-PANSPRAY	205	0-127	-1.0 .. +1.0	Linear
CC	MOD LIFT-AMP	206	0-127	-1.0 .. +1.0	Linear
CC	MOD LIFT-PANSPRAY	207	0-127	-1.0 .. +1.0	Linear
CC	MOD VELO-AMP	208	0-127	-1.0 .. +1.0	Linear
CC	MOD VELO-PANSPRAY	209	0-127	-1.0 .. +1.0	Linear
CC	Resample anti-alias on/off	210	0..1	NOTE: used to be CC37 in firmware prior to 2.2!	
CC	Tapeslew	211	0-127	0.0..1.0	Linear
CC	LFO1MUL	212	0..9	LFO1 MIDI clock multiplier - 1	-
CC	LFO1DIV	213	0..9	LFO1 MIDI clock divider - 1	-
CC	LFO2MUL	214	0..9	LFO2 MIDI clock multiplier - 1	-
CC	LFO2DIV	215	0..9	LFO2 MIDI clock divider - 1	-
Timing	Clock	120	-	Clock tick to drive MIDI clock enabled controls.	-
Timing	Start	122	-	Ignored, but accepted	-
Timing	Continue	123	-	Ignored, but accepted	-
Timing	Stop	124	-	Ignored, but accepted	-
Timing	Active sensing	125	-	Ignored, but accepted	-
Timing/ Aux	Reset	126		Stop all voices.	

## Precision MIDI: "NRPN"

The GR-1 also supports all the above CC parameters as Non-Registered Parameters Numbers (NRPN). This means you can use the normal 7 bit MIDI values, but also use 14 bit values if necessary. This allows for more than 128 controls, and for control values with 16384 steps instead of the normal 128.

All CC's that have range 0-127 (not the toggles, or triggers) are also available as 14 bit precision NRPN's. Since the GR-1 has many parameters that demand high precision, like sample position or filter cutoff, this feature exposes the full potential of GR-1 to MIDI controllers and sequencers.

Note that the GR-1's large modulation matrix is not fully represented as normal 7 bit CC, but also uses CC's that are only available as NRPN.

An NRPN is just 4 CC packets being sent:



CC header byte (176 + channel), 99, NRPN parameter MSB (upper 7 bit of CC number from above table)

CC header byte (176 + channel), 98, NRPN parameter LSB (lower 7 bit of CC number from above table)

CC header byte (176 + channel), 6, NRPN value MSB (high 7 bit of the 14 bit value)

CC header byte (176 + channel), 38, NRPN value LSB (low 7 bit of the 14 bit value)

For example, let's take parameter 2 (sample position) and set that to sample position 98.76% of the total length (16181 as a 14 bit number). We're using MIDI channel 1 (that's 0 in the header, since we start counting from 0).

176, 99, 0

176, 98, 2

176, 6,  $16181 \div 128 = 126$

176, 38,  $16181 \bmod 128 = 53$

## Firmware updates

**WARNING:** NEVER power down your GR-1 while updating the firmware. Data corruption may occur! Even in the extreme case of a freeze during update, please wait at least 30 seconds before attempting to power off!! If the above are not respected, the GR-1 may fail to boot on the next power up! You can then only recover through flashing the internal SD card, losing all your internally stored performances.

The GR-1 firmware can be updated via USB, and since version 2.0 also via the LAN port. To perform a firmware update via USB: download the latest version on [www.tastychips.nl/gr-1-support](http://www.tastychips.nl/gr-1-support) and follow the next steps:

- Place the gr1\_firmware\_vx.y.z\_abcdefgh.tgz file in the “root directory” on a USB drive.
- **DO NOT UNZIP the tgz file!**
- Insert the USB drive in one of the 4 USB ports on your GR-1.

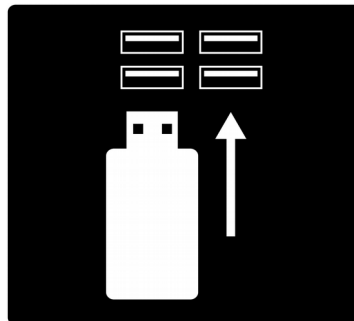

Alternatively, to perform a firmware update via the LAN port: please plug in a LAN cable from your router to the GR-1's LAN port. The LAN port is situated directly next to the 4 USB ports. LAN update is only available in firmware v2.0 onwards.

- Turn on/restart your GR-1, you will now see a window popping up
- Press “select” within 5 seconds to perform the firmware update



The firmware update will now start and takes less than a 30 seconds

- Remove the USB disk and restart the GR-1

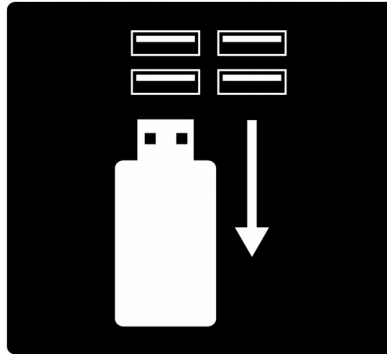

Keep in mind that when there is a firmware update in the root directory of a connected USB drive, the GR-1 will always boot with the “press “Select” to update” window. You might want to remove the firmware update from the USB drive when the update is done. The actual firmware version can be found here in the configuration menu (top right).

For updating without a reset first: From version 1.2 onwards it’s possible to use the Performance menu to enter the update screen:

- Go to Preferences -> General
- Shift+Perf
- Select “Check Firmware Upgrade”
- Push the Select knob (or turn on old firmwares).

See the troubleshooting chapter if you run into problems with updating.

## Frequently Asked Questions (FAQ)

*Q: Why does the GR-1 come without a IEC power cable?*

A: This is because most people have at least a couple of these cables lying around left over from older discarded devices. It's better for the environment.

*Q: Why does the GR-1 come without a printed manual?*

A: Because the manual receives significant updates every few months, and it saves the environment.

*Q: How to store performance/global menu settings like midi channel, led brightness, etc?*

A: See the section "Performance quick save". Note that saving to /internal/performance 1 will restore these settings on GR-1 startup.

*Q: I want to use the GR-1 as a normal sampler without granulation going on. How to do this?*

A: Patch menu (Shift+Patch) -> Sample mode -> Audition.

*Q: There's just one filter? Is it then paraphonic? How to use the gr-1 as a fully polyphonic device?*

A: You can use MIDI MPE devices to achieve full polyphony. You can use sampled sweeps to emulate the polysynth's typical filter envelopes. Without MPE it indeed is somewhat paraphonic.

*Q: My USB stick or drive isn't working with the GR-1. How do I get it to work?*

A: See the troubleshooting section about USB drives.

*Q: My USB sound card isn't working with the GR-1. Is it supported at all?*

A: Only the so-called class compliant USB sound cards are supported. Others, especially most expensive or older cards require special driver support, and the GR-1 doesn't have that. However, there are hundreds of class compliant USB sound cards out there. Check the list in "Supported USB sound cards" for more information.

*Q: I have audio dropouts or a lowering of the density parameter. What is this, and how to avoid?*

A: See the "Polyphony" chapter.

*Q: The grain density seems to oscillate when there are a lot of grains (combination of high density and high grain size settings). What is this?*

A: This is normal. Per voice you can "only" have 128 simultaneous grains. The grain scheduler wants to add more, but the system refuses. Then some grains reach their end, and the scheduler can add grains again. This causes an oscillation. The trick is to limit the combination of the grain size and density setting a bit, and then the density will be constant. Another way is to raise the Grain stealing threshold. Standard this is 0 (no stealing).

*Q: I want to hook a GR-1 up to my DAW, how does this work?*

A: There are two ways:

1. DIN MIDI: Use a USB-to-DIN MIDI adapter/sound card, and hook it up to the GR-1's MIDI IN DIN port. This works well enough for standard MIDI controls like notes, pitch bend, and the odd CC. However, a DIN MIDI connection is not the best if you want to have a lot of smooth automations.
2. USB host-to-host interface. For instance, the iConnectivity mio2. As you may know the GR-1 has only USB A ports, and is a USB host. Your PC or Mac is also a host. There are no ways to directly make a USB connection between them. A host-to-host interface takes care of this.

*Q: Sometimes, when switching to a new preset, a parameter resets itself. What is this, and how to avoid?*

A: Since switching presets gives each knob a potentially different value, the actual knob position may not represent the underlying value anymore. Since the knobs are quite sensitive they may pick up the slightest movement or even noise in the system. To remedy this you can use "Setpoints" in the performance menu. That way the knobs are locked when switching presets. The lock disappears when you turn it to the actual value.

*Q: I want to save separate patches and samples to internal storage. Is that possible?*

A: It's only possible to store performances to internal storage. But using a so-called "performance quick save" is actually much faster and easier than saving a separate patch. Please look it up in this manual. It is not allowed to store separate patches and samples to internal storage. The reason for this is that the internal storage is limited and there's no delete function.

*Q: I want to rename the performances in the internal storage. Is that possible?*

A: Sorry, no. For this, use a USB stick with folders you have created and named yourself.

*Q: In multitimbral mode, sometimes I cannot enable a specific part. What is this?*

A: The GR-1 doesn't allow the same preset to be active in multiple parts. Please make sure the other parts are assigned to other presets, and then you'll be able to activate this part again.

# Troubleshooting

## File systems (USB disk/stick format)

Using the right format, or *file system*, does help. On a Mac you can use “Disk Utility” and format it like this:

Format: **ExFat**

Scheme: GUID or MBR

In any case it should *not* be FAT32. MacOS (HFS+) is not correctly supported under Linux as of yet, causing to sometimes mount it read-only. APFS is completely unsupported. NTFS is properly supported, but is not readable on Mac. The old FAT32 is not recommended for bigger partitions ( $\geq 32\text{GB}$ ). So, if you want the smoothest experience, please use **ExFat** for everything. For Linux experts: Ext4 is fine as well.

Some USB drives and sticks come with special recovery partitions. Later MacOS formats sticks using such partitions. Older GR-1 firmware ( $<1.4.1$ ) just went ahead and mounted these partitions and allowed you to write to them. But these partitions are small (200 MB or so) and fill up very quickly. Also, they’re hard to access on PC/Mac. From firmware 1.4.1 onwards these partitions are skipped, as they should be. Please upgrade to the latest firmware available. Please contact us if problems persist.

## Multiple USB sticks or USB drives

The GR-1 initially didn’t support multiple USB sticks at the same time. Since firmware v2.1.8 it does support them. Please upgrade to the latest version, and contact us if problems persist.

## Firmware upgrades

Apple’s Safari browser seems to destroy .tgz files when you use the default settings (!). This will cause the update process to get stuck on older firmware! Firmware 1.4 and up do accept this type of mangled file. If you’re upgrading from a firmware older than 1.4, please download the file with another browser like Firefox or Chrome..

..or in Safari:

Alt + mouse click (downloads file instead of opening)

To always download-only instead of opening:

- Go to Preferences -> General
- Uncheck the box “Open “safe” files after downloading”
- Download the .tgz file again

Unfortunately, the Microsoft Edge and Explorer browsers also choose to mangle .tgz files to .gz for some reason. You can rename the extension of the downloaded file from .gz to .tgz, or if you like you can use another browser like Chrome or Firefox.

## Crashes

With early firmware this used to happen more often. Nowadays not so much, It seems that the only ones that occur today are leaving USB devices plugged in at boot (they require too much current for the GR-1 at startup), and plugging USB devices after a firmware update (happens one time only). If this should happen to you, please drop us a mail with specifics of the situation, preferably with screenshot, or better video. Firmware version number and serial number are also highly appreciated.

## Lightning bolts

If you see one of these while booting up, beware!



This means that the Raspberry Pi is having a hard time supplying current to the attached USB devices. Please unplug USB devices while starting up, and only insert them when fully up and running. Preferably one by one. **NEVER** insert USB devices while saving. Unrecoverable data corruption may occur!

## Slow USB drive or stick

Some sticks really are very slow. In our experience the branded ones are a lot faster than the cheap unbranded ones. These are perhaps 4 times slower or worse. Also, older firmware had a “slow” USB mode for compatibility. But since firmware 1.3.3 the GR-1 always runs in fast USB mode and is fully compatible with all USB MIDI controllers. Please upgrade to the latest version.

## Problematic USB stick or drive

It’s a pretty seldom problem, but some USB sticks or hard disks create a lot of inrush current.

When connected while booting, you may see a message like:

```
usb1-1.4: device descriptor read/64, error -32
```

This is basically the USB port freezing up because it has to provide too much current (power). In such a case, remove the USB device, and reboot until the GUI appears and then try attaching it again.

Even if the GR-1 boots up seemingly well with a hard disk, it may be that it has caused latent instability in the system. It’s just better to only connect a hard disk once the GR-1 is fully up and running. Please contact us if you experience similar problems so we can advise and hopefully solve your problem, and improve our future products as well. Thank you.

## Reflashing the internal storage

This section describes a last resort when your GR-1 refuses to boot or has become unstable. Please only follow these steps if all else has failed. It may be that the internal storage, the Micro SD card located in the GR-1's Single Board Computer has become corrupted. So far, it seems that about 1% of the units has experienced this after 2 years. This would seem to suggest that some Micro SD cards are worse than others, or some get used way more often than others. All digital media wear over time, and SD cards are no exception. However, like with all products, some pieces may be more durable than others. This seems comparable to the issues experienced with light bulbs, for instance.

This section is for customers who's GR-1 is out of warranty (older than 2 years), or for customers who still have right to factory warranty (unit less than 2 years old) and cannot afford to wait to receive a new SD card from us. You will need some degree of compute skills in order to reflash the internal storage to a new SD card. If you feel confident enough, read on:

1. Buy a new Micro SD card of at least 32GB. You can find a list of suitable models here:

[https://elinux.org/RPi\\_SD\\_cards](https://elinux.org/RPi_SD_cards)

<https://www.androidcentral.com/best-sd-cards-raspberry-pi-4>

2. Download Balena Etcher, or the Raspberry Pi Imager tool (Balena doesn't seem to work well on OSX Catalina a user reported):

<https://www.balena.io/etcher/>

<https://www.raspberrypi.org/downloads/>

3. Download the following image from our site:

[https://www.tastychips.nl/downloads/gr-1\\_1.6.1\\_50perf.img.zip](https://www.tastychips.nl/downloads/gr-1_1.6.1_50perf.img.zip)

4. Use Balena Etcher / Raspberry Pi Imager to write the image to the new SD card. You'll need a USB adapter for the Micro SD card or a card reader on your PC/Mac.

5. Power down the GR-1 and unscrew the GR-1's casing. The unscrewing consists of 7 countersunk M3 screws in total.

6. Remove the old SD card from the Single Board Computer (typically a Raspberry Pi 3B).

7. Insert the new SD card and use a bit of duck tape or electrical tape to fasten it in the slot, just in case you'll be moving the GR-1 around a lot.

8. Start up the GR-1. It will reboot by itself to expand the file system to the full size of the SD card. Once it has fully booted test some basic functionality like the play button.



9. You'll now upgrade from the basic 1.6 image to the latest firmware: Follow the upgrade procedure described in the "Firmware upgrades" chapter. This is USB only since v1.6 firmware only understands upgrades over USB and not yet those over internet.

10. Your GR-1 should now be ready to face the next couple of years. Firmware updates from hereon may be performed over internet.

# Credits

## Tasty Chips Team

- Pieter van der Meer (Founder of Tasty Chips Electronics, Lead engineer)
- Jasper Andrea (Andrea Audio Productions)
- Koen Pepping (Vannes Engineering)
- Luc Derks (Sound design, QA, Illustration)

## Hired

- Niels Johannes de Wit (Software engineering)
- Bas van Geuns (Intro Animation video)
- Marco Galtarossa (3D renders)

## Hardware Granular Idea

- Erwin Tuijl (Pocket Knife Army)

# Special thanks to

## Brainstorm sessions

- Erwin Tuijl (Pocket Knife Army)
- Jasper Schutz
- Job de Klein
- Leon Stok
- Peter Johan Nyland
- Igor Zinken
- Lennart Denninger

## Feedback, tips and others

- Ad Nieuwenhuizen
- Nico Sijm

## Contact

### Tasty Chips Electronics

Email: [info@tastychips.nl](mailto:info@tastychips.nl)

Website: [www.tastychips.nl](http://www.tastychips.nl)

Youtube: <https://www.youtube.com/tastychips>

Facebook: <https://www.facebook.com/tastychipselectronics>

Fb user group: <https://www.facebook.com/groups/141549229871409>

